



**SIMPSON**

**Strong-Tie**

®

# CATALOG KATALOG CATALOG

**EAST EUROPE  
VÝCHODNÍ EVROPA  
EUROPA DE EST**

2011/2012

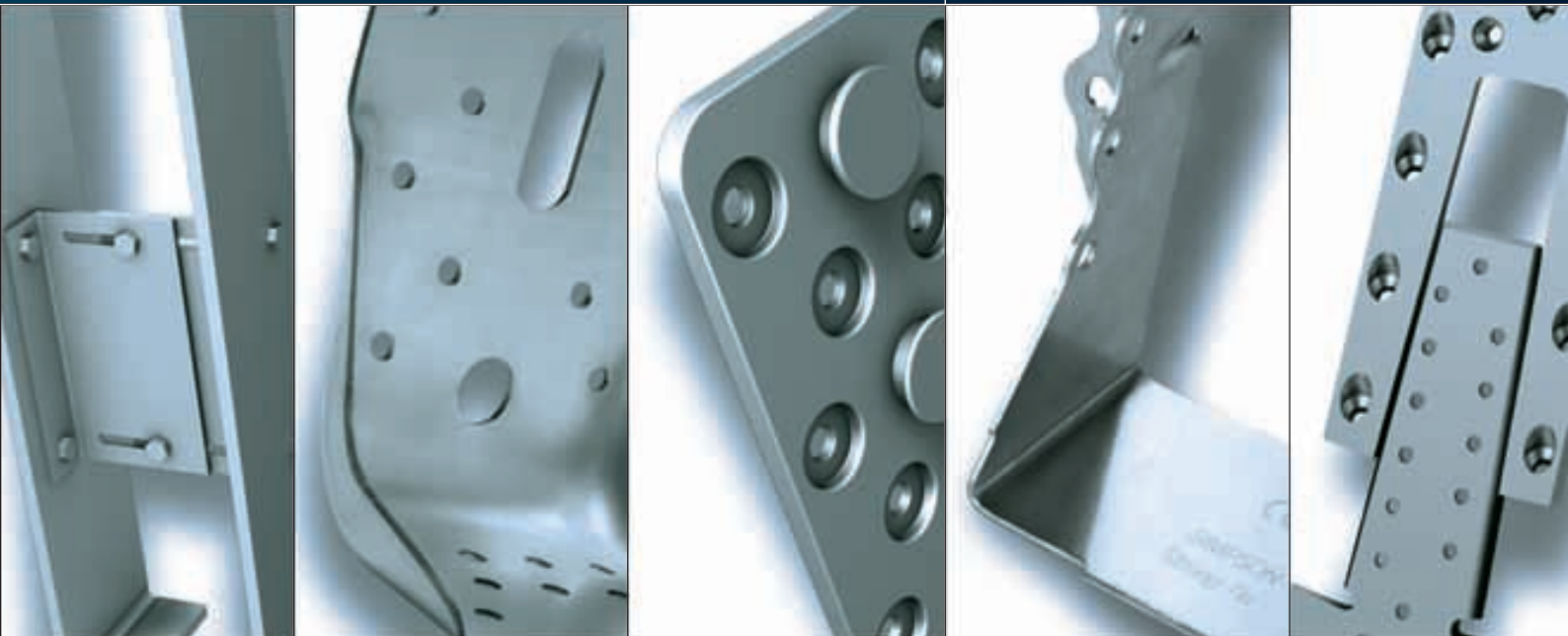

**EAST 2011/2012**

[www.strongtie.cz](http://www.strongtie.cz)  
[www.strongtie.eu](http://www.strongtie.eu)

	Name of chapter/Názvy kapitol/Titlu capitol	Chapter/Kapitola/Capitol	Page/Stránka/Pagina
Content according to products Obsah podle produktů Cuprins în funcție de produs			2a-2b
Content Obsah Continut			3-7
	Angle bracket / Úhelník / Coltar de imbinare	1	8-11
	Joist hanger / Trámová botka / Papuc grinda; Joist and support bracket/Skrytá trámová botka/Suport grinda	2	12-24
	Universal bracket/Univerzální spojka/Element de imbinare universal; Purlin anchor/Spojka vaznice-krokev/Ancora pana de caprior	3	25-28
	Steel strap/Děrované pásy/Banda perforata; Windbracing strap/Zavětrovací pásy/Banda de imbinare	4	28-32
	Nail plates/Děrované styčnickové plechy/Placa perforata; Truss clip/Osedláni krokve/Element de imbinare	5	33-36
	Cantilever bracket/Gerberova spojka/Element de prindere si de fixare grinda	6	36-37
	Column shoe/Patka sloupku/Papuc reazem	7	38-49
	HE-anchor/HE-kotva/Ancora H din otel; Profil anchor/Profilová kotva/Ancora de sustinere; Connection profile/Připojovací profily/conexiune profil	8	50
	Terrace clips/Terasové klipy/ Clipuri terasa	9	51-52
	Stainless steel connector/Nerezové spojky/Conectori din otel inoxidabil	10	53
	Tension Tie/Tažná kotva/Legatura de colt	11	54-56
	House and garden/Dům a zahrada/Casa si Gradina	12	57-59
	Fasteners/Spojovací materiál/Elemente de fixare	13	59-64

<b>A</b>	Page Stránka Pagina
<b>Angle Bracket</b>	
AA (60280)	8
AB105	8
AB36125	11
AB70, AB90	8
AB55365	9
ABB40390	8
ABR (100, 105, 170, 70, 90, 9015, 9020)	9
AC35350	9
ADR (6035, 6090, 6191, 6292)	9
AE (116, 48, 76)	10
AF90265	9
AG (40312, 40314, 40412, 40414)	10
AH (16050, 19050, 29050, 9035)	56
AJ (60416, 80416, 99416)	10
AKR, ANP	10
ANPS	11
BNV33	11
CRE	57
E20/3	9
EBR	57
EC	57
EFIXR	57
FLVW	57
KNAG	11
RFC	57
SBV	59
<b>ATF</b>	
ATF	21
<b>B</b>	Page Stránka Pagina
<b>Band unwinder</b>	
BANA	29
<b>Batten nails</b>	
SN	61
<b>Bearing plate bracket</b>	
SHLM, SHLS	35
<b>Bozett</b>	
BO	22
<b>Bulldog</b>	
C1, C2, C3, C4, C5	62
<b>C</b>	Page Stránka Pagina
<b>Case column</b>	
BH54	38
<b>CFR</b>	
CF-R	59

<b>CNA (connector nails)</b>	
CNA	60
<b>Column shoe</b>	
CMR, CPB, CPS	38
JDB, JGB, JGS	49
PA, PB, PBE, PBK	39
PBR, PCR	58
PDKB, PDKS	40, 58
PDL	47, 58
PDS	49
PGS	40
PI, PIL	41
PIS, PISB, PISBMAXI, PISMAXI	42
PJIB, PJIS, PJPB, PJBS	42-43
PL, PLB, PLS,	43-44
PP, PPA, PPB, PPD	44-46
PPL, PPRC, PPS	44-45
PPU	47, 58
PT	58
PTB	47, 58
PU	48
PVD, PVDB, PVIB, PVI, PDB	49
<b>Concrete angle</b>	
ABL, ABS	8
<b>Concrete anchor</b>	
BETA	54
<b>Concrete screw</b>	
SBS	61
<b>Connecting wall strip</b>	
C2KS	50
<b>CP fence bracket</b>	
CP	58
<b>CSA connector screws</b>	
CSA	60
<b>D</b>	Page Stránka Pagina
<b>DLV batten connector</b>	
DLV	28
<b>E</b>	Page Stránka Pagina
<b>E-jot screw</b>	
JT2	55
<b>EL top connector</b>	
EL - EL-S	20
<b>ET joist end grain connector</b>	
ETB	20
<b>EWP - form</b>	
ITSE, IUSE, LSSU, LSSUI, LSTA	24

<b>F</b>	Page Stránka Pagina
<b>FLV flat nail plates</b>	
FLV	34,59
<b>G</b>	Page Stránka Pagina
<b>GEKA press-in shear plate</b>	
C10, C11	63
<b>H</b>	Page Stránka Pagina
<b>HE- profile anchor</b>	
HE	50
<b>Handrails console</b>	
SRC, SRD, SRR	59
<b>I</b>	Page Stránka Pagina
<b>Installation templates</b>	
FRATF, MO	23
<b>J</b>	Page Stránka Pagina
<b>JANE@TU, JANE@TUS</b>	
TU, TUS	19
<b>JANEBO@</b>	
JANEBO@, JHD, JHH	21
<b>Joisthanger</b>	
BSD, BSDI, BSI, BSIL, BSN2P, BSN, BSS, GSE, SBE, SBG	12-18
<b>Joist end support bracket</b>	
BT4, BTN, BTALU	19
<b>K</b>	Page Stránka Pagina
<b>KOLLIBRODD fasteners</b>	
KOL	64
<b>M</b>	Page Stránka Pagina
<b>Milling an installation template</b>	
BTBS, ETPP	23, 38
<b>N</b>	Page Stránka Pagina
<b>Nail plates and nail strip</b>	
NP, MP	33-35
<b>P</b>	Page Stránka Pagina
<b>Purlin anchor</b>	
SPF	26
<b>Plates for U-shoe</b>	
PUA/B	48
<b>Post shoe, post support shoe, post support</b>	
PPH, PPHB, PPJ, PH	41,58

<b>Practillet® steel strap</b>	
FBAR, FBPR	29,59
<b>Profile anchor</b>	
PROFA	50
<b>Purlin anchor</b>	
PFE, PFU	26,27
<b>S</b>	Page Stránka Pagina
<b>Splitring</b>	
B1, A1	63
<b>SPAX® screw</b>	
SPAX	59
<b>Steel dowels</b>	
STD	61
<b>Stair case angles</b>	
TA	57
<b>T</b>	Page Stránka Pagina
<b>Tension strap</b>	
BANSTR, BANSTRS	30
<b>Tension tie</b>	
AH, HD, HD2P, LTT, HTT	54-56
<b>Terrace connectors, Terrace clip</b>	
DBCS, DBT1Z, HDMS, EB-TY	51-52
<b>Truss shoe, Truss clip</b>	
GER, SHB, SHH, SFH, SFHM, SFHS, SFM, SFN	35-37
<b>T-Profile</b>	
TALU	22
<b>Top batten</b>	
TOP, TOL	27
<b>U</b>	Page Stránka Pagina
<b>Universal bracket</b>	
UNI	25
<b>U-Washer</b>	
US	55, 64
<b>U-shoe</b>	
PUA	48
<b>W</b>	Page Stránka Pagina
<b>Windbracing</b>	
BAN, BN, BNW	28, 30-32

Items number NEW Číslo položky nové Numar NOI articole	Item description/Popis položky/Articole descriere	Chapter Kapitola Capitol	Page Stránka Pagina
AA60280	Angle bracket 60280 • Úhelník 60280 • Coltar de imbinare 60280	1	8
AB105	Angle bracket 105 o/R • Úhelník 105 o/R • Coltar de imbinare o/R	1	8
AB36125 u. 6983	Angle bracket • Úhelník • Coltar de imbinare	1	11
AB70	Angle bracket 70 o/R • Úhelník 70 o/R • Coltar de imbinare 70 o/R	1	8
AB90	Angle bracket 90 o/R • Úhelník 90 o/R • Coltar de imbinare 90 o/R	1	8
ABB40390	Angle bracket 40390 • Úhelník 40390 • Coltar de imbinare 40390	1	8
ABL	Concrete angle P • Úhelník do betonu P • Ungiul de beton P	1	8
ABR100	Angle bracket • Úhelník • Coltar de imbinare	1	9
ABR105	Angle bracket 105 • Úhelník 105 • Coltar de imbinare 105	1	9
ABR170	Angle bracket 170 • Úhelník 170 • Coltar de imbinare 170	1	9
ABR70	Angle bracket 70 m/R • Úhelník 70 m/R • Coltar de imbinare 70 m/R 7070m/R	1	9
ABR90	Angle bracket 90 • Úhelník 90 • Coltar de imbinare 90	1	9
ABR9015	Angle bracket 9015 • Úhelník 9015 • Coltar de imbinare 9015	1	9
ABR9020	Angle bracket 9020 • Úhelník 9020 • Coltar de imbinare 9020	1	9
ABS	Concrete angle S • Úhelník do betonu S • Unghi de beton S	1	8
AB55365	Angle bracket 55365 • Úhelník 55365 • Coltar de imbinare 55365	1	9
AC35350	Angle bracket AC35350 • Úhelník AC35350 • Coltar de imbinare AC35350	1	9
ADR6035	Angle bracket 6035 • Úhelník 6035 • Coltar de imbinare 6035	1	9
ADR6090	Angle bracket 6090 • Úhelník 6090 • Coltar de imbinare 6090	1	9
ADR6191	Angle bracket 6191 • Úhelník 6191 • Coltar de imbinare 6191	1	9
ADR6292	Angle bracket 6292 • Úhelník 6292 • Coltar de imbinare 6292	1	9
AE116	Angle bracket 90x48x3,0x116 • Úhelník 90x48x3,0x116 • Coltar de imbinare 90x48x3,0x116	1	10
AE48	Angle bracket 90x48x3,0x48 • Úhelník 90x48x3,0x48 • Coltar de imbinare 90x48x3,0x48	1	10
AE76	Angle bracket 90x48x3,0x76 • Úhelník 90x48x3,0x76 • Coltar de imbinare 90x48x3,0x76	1	10
AF90265	Angle bracket 90265 • Úhelník 90265 • Coltar de imbinare 90265	1	9
AG40312	Angle bracket 40312 • Úhelník 40312 • Coltar de imbinare 40312	1	10
AG40314	Angle bracket 40314 • Úhelník 40314 • Coltar de imbinare 40314	1	10
AG40412	Angle bracket 40412 • Úhelník 40412 • Coltar de imbinare 40412	1	10
AG40414	Angle bracket 40414 • Úhelník 40414 • Coltar de imbinare 40414	1	10
AH	Tension tie • Tažná kotva • Legatura de colt	11	56
AH16050	Angle bracket 160x50x3,0x40 (Tension tie) • Úhelník 160x50x3,0x40 (Tažná kotva) • Coltar de imbinare 160x50x3,0x40 (Legatura de colt)	11	56
AH19050	Angle bracket 190x50x2,0x40 (Tension tie) • Úhelník 190x50x2,0x40 (Tažná kotva) • Coltar de imbinare 190x50x2,0x40 (Legatura de colt)	11	56
AH29050	Angle bracket 290x50x2,0x40 (Tension tie) • Úhelník 290x50x2,0x40 (Tažná kotva) • Coltar de imbinare 290x50x2,0x40 (Legatura de colt)	11	56
AH9035	Angle bracket 90x35x2,5x40 (Tension tie) • Úhelník 90x35x2,5x40 (Tažná kotva) • Coltar de imbinare 90x35x2,5x40 (Legatura de colt)	11	56
AJ60416	Angle bracket 60416 • Úhelník 60416 • Coltar de imbinare 60416	1	10
AJ80416	Angle bracket 80416 • Úhelník 80416 • Coltar de imbinare 80416	1	10
AJ99416	Angle bracket 99416 • Úhelník 99416 • Coltar de imbinare 99416	1	10
AKR	Angle bracket KR perforated metal • Úhelník KR perforovaný kov • Coltar de imbinare metalic perforate	1	10
ANP	Angle bracket from perforated plates (2,5 mm) • Úhelník z perforovaného plechu(2,5mm) • Coltar de imbinare metalic perforata(2,5mm)	1	10
ANPS	Angle bracket from perforated plates (2 mm) • Úhelník z perforovaného plechu(2mm) • Coltar de imbinare metalic perforata(2mm)	1	11
ATF	ATF	2	21

Items number NEW Číslo položky nové Numar NOI articole	Item description/Popis položky/Articole descriere	Chapter Kapitola Capitol	Page Stránka Pagina
B1, A1	Splitring (APPEL) • Prstencová klínová hmoždinka(APPEL) • Dibluri cu pana inelara(APPEL)	13	63
BAN	Windbracing strap • Zavětrovací děrované pásky • Banda de imbinare si banda perforata	4	28
BANA	Band unwinder • Odvíječ pásky • Suport pentru rola banda perforata	4	29
BANSTR	Tension strap • Dopínací spojka • Aparat de intindere	4	30
BANSTRS	Tension strap S® • Dopínací spojka S® • Aparat de intindere S®	4	30
BETA	Concrete anchor • Kotva do betonu • Ancora beton	11	54
BH54	Case column shoe • Pouzdro patky sloupku • Carcasa papuc reazem	7	38
BN	Windbracing system • Systém zavětrování • Sistem de contravantuire	4	30, 31
BNV33	Angle bracket 33x61x1,5x180 • Úhelník 33x61x1,5x180 • Coltar de imbinare 33x61x1,5x180	1	11
BNW	Windbracing brackets • Připojení zavětrovací pásky • Racorduri de contravantuire	4	32
BO	Bozett	2	22
BSD	Joisthanger with perforated plates • Trámová botka s děrovaným plechem • Papuc grinda cu placi perforate	2	16
BSDI	Joisthanger with perforated plates type I • Trámová botka s děrovaným plechem typ I • Papuc grinda cu placi perforate tip I	2	16
BSI	Joisthanger type I • Trámová botka typ I • Papuc grinda tip I	2	13
BSIL	Joisthanger type IL • Trámová botka typ IL • Papuc grinda tip IL	2	17
BSN	Joisthanger • Trámová botka • Papuc grinda	2	12
BSN2P	Joisthanger 2-parts • Trámová botka dělená • Papuc grinda reglabil pe 2-parti	2	17
BSS	Joisthanger S • Trámová botka S • Papuc grinda S	2	18
BT4	Joist end support bracket 4-rows • Skrytá trámová botka 4-řady • Suport grinda 4 randuri	2	19
BTALU	ALU joist end support bracket • ALU skrytá trámová botka • Suport grinda ALU	2	19
BTBS	Milling and installation template for EL • Frézovací a montážní šablona pro spojku EL • Sabloane de frezare si montaj pentru EL	2, 7	23, 38
BTN	Joist end support bracket • Skrytá trámová botka • Suport grinda	2	19
C1, C5, C3	Bulldog double sided toothting • Bulldog oboustranné ozubení • Prevazut cu dantura pe ambele parti	13	62
C10, C11	GEKA press-in shear plate • GEKA stlačovací hmoždinka • Dibluri de presare GEKA	13	63
C2, C4	Bulldog one sided toothting • Bulldog jednostranné ozubení • Prevazut cu dantura pe singura parte	13	62
C2KS	Connecting wall strip • Připojovací pás do zdi • Benzi de perete conectoare	8	50
CF-R	CFR angle bracket • CFR úhelníky • Coltar de imbinare CFR	12	59
CMR	Column shoe CMR • Patka sloupku CMR • Papuc reazem CMR	7	38
CNA	CNA connector nails • CNA kotevní hřebíky • Cui ancora CNA	13	60
CP	CP fence bracket • CP plotové kování • Feronerie pentru garduri CP	12	58
CPB	Column shoe CPB • Patka sloupku CPB • Papuc reazem CPB	7	38
CPS	Column shoe CPS • Patka sloupku CPS • Papuc reazem CPS	7	38
CRE	Angle bracket CRE • Úhelník CRE • Coltar de imbinare CRE	12	57
CSA	CSA connector screws • CSA kotevní šrouby • Cui surub CSA	13	60
DLV	DLV batten connector • DLV spojky střešních latí • Sistem de imbinare pentru sipca acoperis DLV	3	28
DBCS	Terrace connectors • Terasová spojka • Conectori terase	9	51
EB-TY®	Terrace connectors • Terasová spojka • Conectori terase	9	52
DBT1Z	Terrace clip • Terasový klip • Clip terase	9	51
E20/3	Angle bracket E20/3 • Úhelník E20/3 • Coltar de imbinare E20/3	1	9
EBR	Angle bracket for rounded timber • Úhelník oblý • Coltar de imbinare pentru profile rotunde	12	57
EC	Angle bracket (stand) • Úhelník (stojkový) • Coltar de imbinare (stand)	12	57
EFIXR	Angle bracket EFIXR • Úhelník EFIXR • Coltar de imbinare EFIXR	12	57
EL - EL-S	EL top connector • EL skrytá trámová botka • Coltar de imbinare top EL	2	20
ETB	ET joist end grain connector • Skrytá trámová spojka ET • Piesa de cuplare grinda ET	2	20

Items number NEW Číslo položky nové Numar NOI articole	Item description/Popis položky/Articole descriere	Chapter Kapitola Capitol	Page Stránka Pagina
ETTP	Milling and installation template for ET • Frézovací a montážní šablona pro spojku ET • Sabloane de frezare si montaj pentru ET	2	23
FBAR	Practillet® steel strap • Practillet® děrovaná páska • Practillet® banda perforata	4, 12	29, 59
FBPR	Practillet® steel strap • Practillet® děrovaná páska • Practillet® banda perforata	4, 12	29, 59
FLV	FLV flat nail plates • FLV ploché spojky • Conectori plati FLV	5, 12	34, 59
FLW	Angle bracket • Úhelník • Coltar de imbinare	12	57
FRATF	Installation templates for ATF • Montážní šablona pro ATF • Sabloane de montaj pentru ATF	2	23
GER	Truss shoe • Osedláni krokve • Suporti de capriora	6	36, 37
GSE	Joisthanger • Trámová botka • Papuc grindă	2	18
HD	Tension tie • Tažná kotva • Legatura de colt	11	54
HD2P	Tension tie included washer • Tažná kotva včetně podložky • Legatura de colt inclusive saira	11	55
HDMS	Terrace clip • Terasový klip • Clip terasă	9	51
HE	HE-Profile anchor • HE-profilová kotva • Ancora de susținere HE	8	50
HTT	Tension tie • Tažná kotva • Legatura de colt	11	55
ITSE - IUSE	EWP-Form • EWP-tvarovky • Piese profilate EWP	2	24
JDB	Column shoe JDB • Patka sloupku JDB • Papuc reazem JDB	7	49
JGB	Column shoe JGB • Patka sloupku JGB • Papuc reazem JGB	7	49
JGS	Column shoe JGS • Patka sloupku JGS • Papuc reazem JGS	7	49
JHD - JHH	JANEBO®	2	21
JT2	E-Jot screw • E-jot šroub • Surub E-jot	11	55
KNAG	Angle bracket KNAG • Úhelník KNAG • Colțair de imbinare KNAG	1	11
KOL	KOLLIBRODD fasteners • KOLLIBROD spojka • Elemente de fixare KOLLIBROD	13	64
LSSU, LSSUI, LSTA	EWP-Form • EWP-tvarovky • Piese profilate EWP	2	24
LTT	Tension tie • Tažná kotva • Legatura de colt	11	55
MO	Installation templates • Instalační šablona • Sabloane de montaj pentru	2	23
MP	MP nail plates • MP styčnickové desky • Placi pentru fixare in cuie MP	5	35
NP	Nail plates and nail plates strip • Děrované plechy a pásy • Placi si banda perforata	5	33, 34
PA	Column shoe PA • Patka sloupku PA • Papuc reazem PA	7	39
PB	Column shoe PB • Patka sloupku PB • Papuc reazem PB	7	39
PBE	Column shoe BL • Patka sloupku BL • Papuc reazem BL	7	39
PBK	Column shoe BK • Patka sloupku BK • Papuc reazem BK	7	39
PBR NEU	Column shoe PBR24/50G • Patka sloupku PBR24/50G • Papuc reazem PBR24/50G	12	58
PCR NEU	Column shoe PCR24/50G • Patka sloupku PCR24/50G • Papuc reazem PCR24/50G	12	58
PDB	Column shoe DB • Patka sloupku DB • Papuc reazem DB	7	49
PDKB	Column shoe DKB • Patka sloupku DKB • Papuc reazem DKB	7, 12	40, 58
PDKS	Column shoe DKS • Patka sloupku DKS • Papuc reazem DKS	7, 12	40, 58
PDL	Column shoe DL • Patka sloupku DL • Papuc reazem DL	7, 12	47, 58
PDS	Column shoe DS • Patka sloupku DS • Papuc reazem DS	7	49
PFE	Purlin anchor E • Spojka vaznice-krokev E • Ancora de pana caprior E	3	26
PFU	Purlin anchor U • Spojka vaznice-krokev U • Ancora de pana caprior U	3	27
PGS	Column shoe GS • Patka sloupku GS • Papuc reazem GS	7	40
PH	Post support • Sloupková kotva do betonu • Ancore de reazem	7, 12	41, 58
PI	Column shoe I • Patka sloupku I • Papuc reazem I	7	41
PIL	Column shoe IL • Patka sloupku IL • Papuc reazem IL	7	41
PIS	Column shoe IS • Patka sloupku IS • Papuc reazem IS	7	42

Items number NEW Číslo položky nové Numar NOI articole	Item description/Popis položky/Articole descriere	Chapter Kapitola Capitol	Page Stránka Pagina
PISB	Column shoe ISB • Patka sloupku ISB • Papuc reazem ISB	7	42
PISBMAXI	Column shoe ISB MAXI • Patka sloupku ISB MAXI • Papuc reazem ISB MAXI	7	42
PISMAXI	Column shoe IS MAXI • Patka sloupku IS MAXI • Papuc reazem IS MAXI	7	42
PJIB	Column shoe JIB • Patka sloupku JIB • Papuc reazem JIB	7	42
PJIS	Column shoe JIS • Patka sloupku JIS • Papuc reazem JIS	7	42
PJPB	Column shoe JPB • Patka sloupku JPB • Papuc reazem JPB	7	43
PJBS	Column shoe JBS • Patka sloupku JBS • Papuc reazem JBS	7	43
PL	Column shoe PL • Patka sloupku PL • Papuc reazem PL	7	43
PLB	Column shoe PLB • Patka sloupku PLB • Papuc reazem PLB	7	44
PLS	Column shoe PLS • Patka sloupku PLS • Papuc reazem PLS	7	44
PP	Column shoe P • Patka sloupku P • Papuc reazem P	7	46
PPA	Column shoe PPA • Patka sloupku PPA • Papuc reazem PPA	7	44
PPB	Column shoe PB • Patka sloupku PB • Papuc reazem PB	7	45
PPD	Column shoe D • Patka sloupku D • Papuc reazem D	7	46
PPH	Post support shoe H • Přídavná kotva H • Ancore de reazem H	12	58
PPHB	Post support shoe HB • Přídavná kotva HB • Ancore de reazem HB	12	58
PPJ	Post shoe PJ • Sloupková kotva PJ • Ancora de sustinere PJ	12	58
PPL	Column shoe PL • Patka sloupku PL • Papuc reazem PL	7	46
PPRC	Column shoe PPRC • Patka sloupku PPRC • Papuc reazem PPRC	7	44
PPS	Column shoe PS • Patka sloupku PS • Papuc reazem PS	7	45
PPU	Column shoe DK • Patka sloupku DK • Papuc reazem DK	7, 12	47, 58
PROFA	Profile anchor • Profilová kotva • Ancora de sustinere	8	50
PT	Column shoe PT30G • Patka sloupku PT30G • Papuc reazem PT30G	12	58
PTB	Column shoe TB • Patka sloupku TB • Papuc reazem TB	7, 12	47, 58
PU	Column shoe U • Patka sloupku U • Papuc reazem U	7	48
PUA	U-shoe • U-kotva • Ancore U	7	48
PUA/B	Plates for U-shoe • Deska U-kotvy • Placi pentru ancure U	7	48
PVD	Column shoe Vario D • Patka sloupku Vario D • Papuc reazem Vario D	7	49
PVDB	Column shoe Vario D • Patka sloupku Vario D • Papuc reazem Vario D	7	49
PVIB	Column shoe Vario IB • Patka sloupku Vario IB • Papuc reazem Vario IB	7	49
PVI	Column shoe Vario I • Patka sloupku Vario I • Papuc reazem Vario I	7	49
RFC	RFC angle bracket/ • RFC úhelník • Coltar de imbinare RFC	12	57
SBE	Joisthanger SBE • Trámová botka SBE • Papuc grinda SBE	2	14
SBG	Joisthanger SBG • Trámová botka SBG • Papuc grinda SBG	2	15
SBS	Concrete screw SBS • Šroub do betonu SBS • Surub de beton SBS	13	61
SBV	SBV angle bracket • SBV konzolový úhelník • Coltare de consola SBV	12	59
SFH	Truss clip H • Osedláni krokve H • Element de imbinare H	5	35
SFHM	Truss clip HM • Osedláni krokve HM • Element de imbinare HM	5	35
SFHS	Truss clip HS • Osedláni krokve HS • Element de imbinare HS	5	35
SFM	Truss clip MAXI • Osedláni krokve MAX • Element de imbinare MAXI	5	35
SFN	Truss clip Normal SFN • Osedláni krokve Normal SFN • Element de imbinare Normal SFN	5	35
SHB	Truss shoe B • Krokevní botka B • Suporti de capriori B	5	36
SHH	Truss shoe H • Krokevní botka H • Suporti de capriori H	5	36
SHLM	Bearing plate bracket LM • Držák prahů LM • Suport de prag LM	5	35
SHLS	Bearing plate bracket LS • Držák prahů LS • Suport de prag LS	5	35



Items number NEW Číslo položky nové Numar NOI articole	Item description/Popis položky/Articole descriere	Chapter Kapitola Capitol	Page Stránka Pagina
SN	Batten nails • Hřebíky do krokví • Cui ancora	13	61
SPAX	SPAX® screw • SPAX®-šroub • Surub SPAX®	13	59
SPF	Purlin anchor • Spojka vaznice-krokvé • Ancora de pana caprior	3	26
SRC, SRD, SRR	Handrails console • Konzole zábradlí • Paratenza balustrada	12	59
STD	Steel dowels • Kolíky • Tija de fixare	13	61
TA	Stair case angles TA • Úhelník schodový TA • Element de imbinare TA	12	57
TALU	T-Profile ALU • T-profil ALU • Profil aluminiu T	2	22
TOP / TOL	Top batten bracket • Úchytka hřebenové latě • Ancora tip furca	3	27
TU	JANE@TU • Skrytá trémová botka JANE@TU • JANE@TU	2	19
TUS	JANE@TUS • Skrytá trémová botka JANE@TUS • JANE@TUS	2	19
UNI	Universal bracket • Univerzální spojka • Element de imbinare universal	3	25
US	U-Washer • U-podložka • Saiba U	11, 13	55, 64



ETA 06/0106

It. no. NEW č. p. NOVÉ nu. art. NOU	It. no. OLD č. p. STARÉ nu. art. VECHI	Dimensions/Rozměry/Dimen- siuni [mm]			pcs. / package ks./bal. buc./pac.	pallet / pcs. pal./ks palet/buc.	kg / pcs. kg/ks. kg/buc.
		A	B	C			
AA60280 <sup>1)</sup>	0768001 <sup>2)</sup>	83	62	40	50	5100	0,083
AB90-B	0709100 <sup>3)</sup>	88	88	65	100	5000	0,200
AB105	0710601 <sup>3)</sup>	103	103	90	50	2550	0,400
AB70	0707101 <sup>3)</sup>	70	70	55	100	6600	0,108
AB90-135GR-B <sup>1)</sup>	0709200 <sup>3)</sup>	88	88	65	1	–	0,208
AB105-135GR-B <sup>1)</sup>	0710700 <sup>3)</sup>	103	103	90	1	–	0,400

- 1) Currently without ETA / Momentálně bez ETA / In prezent nu ETA  
2) Ripped/se žebrem/cu nervura  
3) Not ripped/bez žebra/fara nervura

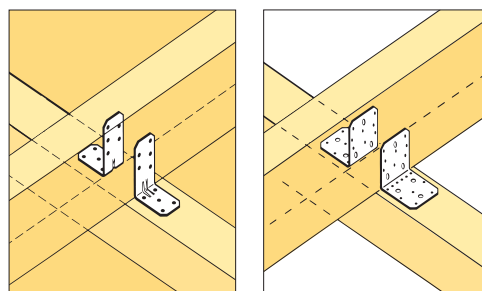
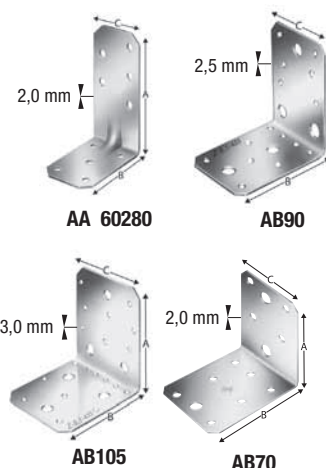

ETA 07/0055 (ABB)

It. no. NEW č. p. NOVÉ nu. art. NOU	It. no. OLD č. p. STARÉ nu. art. VECHI	Dimensions/Rozměry/Dimen- siuni [mm]			pcs. / package ks./bal. buc./pac.	pallet / pcs. pal./ks palet/buc.	kg / pcs. kg/ks. kg/buc.
		A	B	C			
ABB40390	0739001	93	93	40	100	5700	0,161
ABL7514G-B	1001000	75	75	50	50	2900	0,300
ABL10014G-B	1003000	100	75	60	25	1700	0,560
ABL15014G-B	1004000	150	75	60	25	1200	0,750
ABL15017G-B	1004100	150	75	60	25	1200	0,750
ABS10011G-B	1002000	100	50	50	50	1900	0,410
ABS10014G-B	1002100	100	50	50	50	1900	0,410

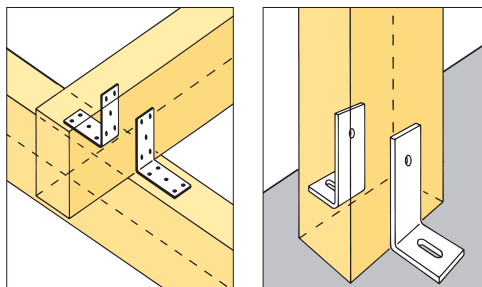



ETA 06/0106 ETA 07/0055

It. no. NEW č. p. NOVÉ nu. art. NOU	It. no. OLD č. p. STARÉ nu. art. VECHI	Dimensions/Rozměry/Dimensiuni [mm]			pcs. / package ks./bal. buc./pac.	pallet / pcs. pal./ks palet/buc.	kg / pcs. kg/ks. kg/buc.
		A	B	C			
ABR9020	–	88	88	65	50	5000	0,168
ABR9015	–	89	89	60	100	3200	0,110
ABR90-B	0709000 <sup>2)</sup>	90	90	65	50	5000	0,208
ABR105-B	0710500 <sup>2)</sup>	105	105	90	50	2550	0,400
ABR105/13-B <sup>1)</sup>	ABR105/13 <sup>2)</sup>	105	105	90	50	2550	0,400
ABR70	0707001 <sup>2)</sup>	70	70	55	50	6500	0,108
ABR100	–	100	100	90	50	1500	0,260
ABR170	ABR170	100	100	90	25	1900	0,170
E20/3	–	170	113	95	25	750	0,583

- 1) Currently without ETA / Momentálně bez ETA / In prezent nu ETA21  
 2) Ripped/se žebrem/cu nervura

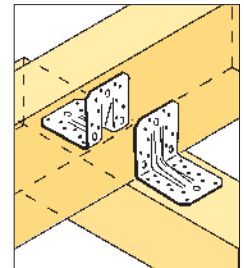
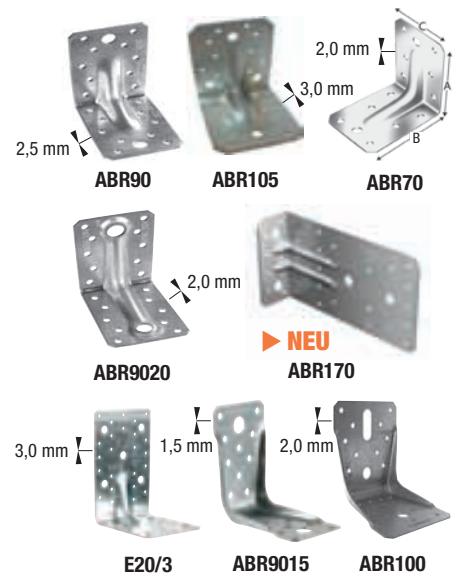

ETA 07/0194

It. no. NEW č. p. NOVÉ nu. art. NOU	It. no. OLD č. p. STARÉ nu. art. VECHI	Dimensions/Rozměry/Dimensiuni [mm]			pcs. / package ks./bal. buc./pac.	pallet / pcs. pal./ks palet/buc.	kg / pcs. kg/ks. kg/buc.
		A	B	C			
AC35350 <sup>1)</sup>	AC35350	50	50	35	100	10200	0,048
AB55365 <sup>1)</sup>	0736501	65	65	55	100	6000	0,125
AF90265 <sup>1)</sup>	0726501	67	67	90	100	4800	0,174
ADR6090	0769001	90	60	60	100	5400	0,164
ADR6035-B	0763500	60	35	60	100	6400	0,100
ADR6191	0769101	90	60	60	100	5400	0,164
ADR6292	0769201	90	60	60	100	5400	0,164

- 1) Currently without ETA / Momentálně bez ETA / In prezent nu ETA

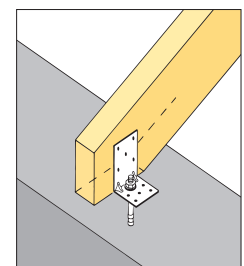
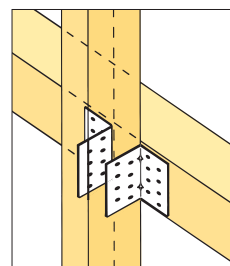
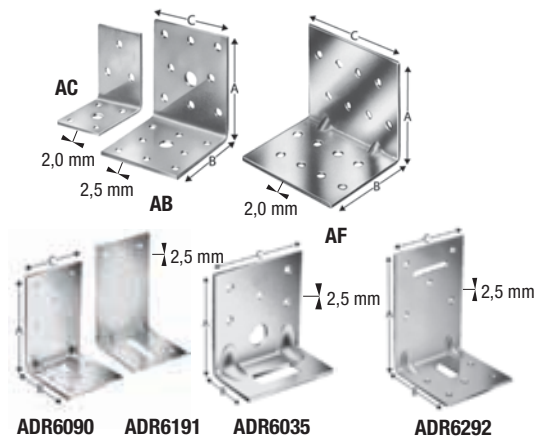



ETA 07/0055

It. no. NEW č. p. NOVÉ nu. art. NOU	It. no. OLD č. p. STARÉ nu. art. VECHI	Dimensions/Rozměry/Dimen- siuni [mm]			pcs. / package ks./bal. buc./pac.	pallet / pcs. pal./ks palet/buc.	kg / pcs. kg/ks. kg/buc.
		A	B	C			
AE48	0704801	90	48	48	100	6000	0,134
AE76	0707601	90	48	76	100	4800	0,206
AE116	0711601	90	48	116	50	2700	0,340
AG40312	0731201	119	91	40	100	5200	0,184
AG40412	0741201	120	92	40	50	3400	0,243
AG40314-B	0731400	141	91	40	50	4300	0,209
AG40414	0741401	142	92	40	50	2900	0,276
AJ60416	0706001	164	84	60	50	1700	0,427
AJ80416	0708001	164	84	80	25	1350	0,588
AJ99416	0709901	164	84	100	25	1350	0,724
AKR95G-B	1005000	95	85	65	25	1200	0,324
AKR95LG-B	1005500	95	85	65	25	1200	0,319
AKR135G-B	1006000	135	85	65	25	1200	0,404
AKR135LG-B	1006500	135	85	65	25	1200	0,398
AKR285G-B	1008000	285	85	65	25	950	0,749
AKR285LG-B	1008500	285	85	65	25	950	0,722
ANP254440 <sup>1)</sup>	0844401	40	40	40	200	16000	0,062
ANP254460 <sup>1)</sup>	0844601	40	40	60	150	7200	0,089
ANP256640 <sup>1)</sup>	0866401	60	60	40	100	11100	0,090
ANP256650 <sup>1)</sup>	0866501	60	60	50	150	8550	0,112
ANP256660 <sup>1)</sup>	0866601	60	60	60	100	7200	0,136
ANP256680 <sup>1)</sup>	0866801	60	60	80	100	4800	0,178
ANP2566100 <sup>1)</sup>	0866101	60	60	100	50	3750	0,220
ANP258860 <sup>1)</sup>	0888601	80	80	60	100	5400	0,178
ANP258880 <sup>1)</sup>	0888801	80	80	80	50	3800	0,240
ANP2588100-B <sup>1)</sup>	0888100	80	80	100	50	2700	0,298
ANP25101060 <sup>1)</sup>	0811601	100	100	60	50	3400	0,224
ANP25101080-B <sup>1)</sup>	0811800	100	100	80	50	3400	0,296
ANP251010100 <sup>1)</sup>	0811101	100	100	100	50	2400	0,372
ANP254660 <sup>1)</sup>	0846601	40	60	60	150	8550	0,111
ANP256860 <sup>1)</sup>	0868601	60	80	60	100	5400	0,157
ANP2561060-B <sup>1)</sup>	0861600	60	100	60	100	5400	0,178
ANP251020100-B <sup>1)</sup>	0812100	100	200	100	25	1600	0,560

1) Currently without ETA / Momentálně bez ETA / In prezent nu ETA

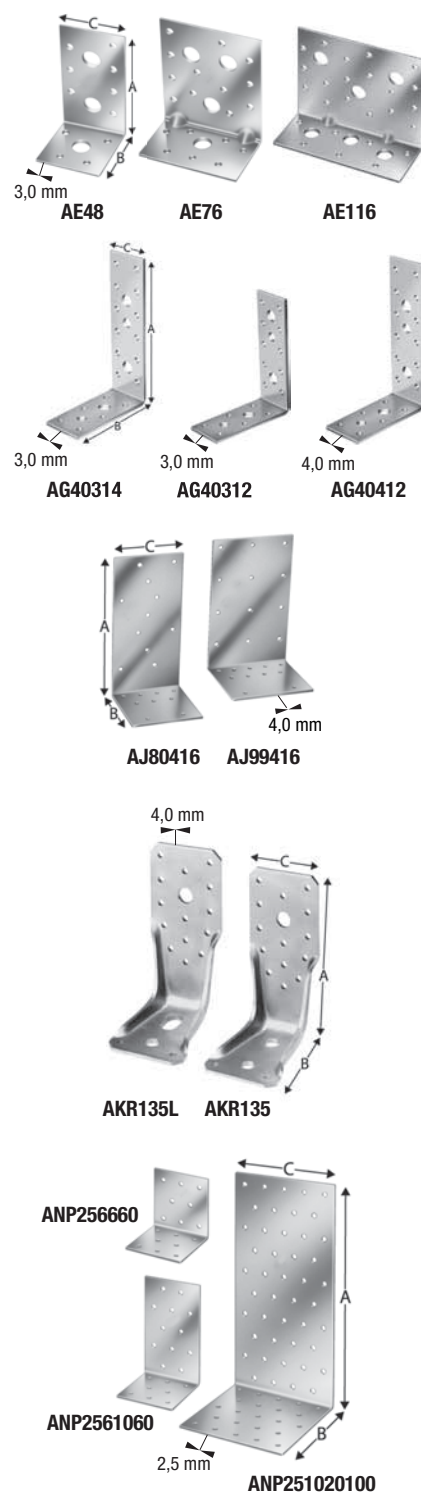

Copyright: © Simpson Strong-Tie® - EAST-2011/2012 01.05.2011

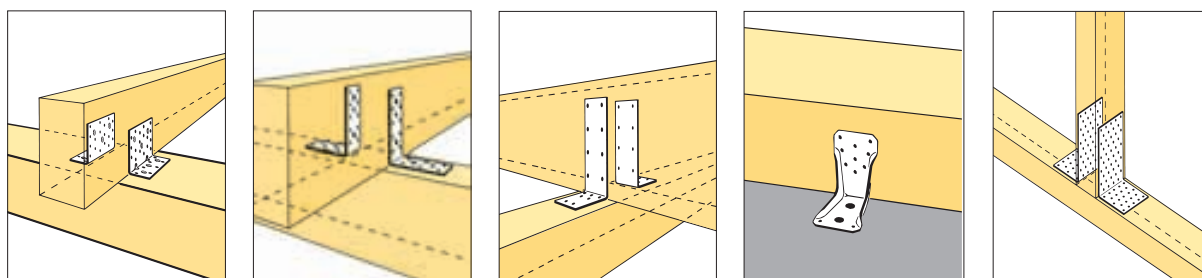



ETA 07/0055

It. no. NEW č. p. NOVÉ nu. art. NOU	It. no. OLD č. p. STARÉ nu. art. VECHI	Dimensions/Rozměry/Dimensi- uni [mm]			pcs. / package ks./bal. buc./pac.	pallet / pcs. pal./ks palet/buc.	kg / pcs. kg/ks. kg/buc.
		A	B	C			
ANPS204425 <sup>1)</sup>	3000101	40	40	25	200	16200	0,031
ANPS204440 <sup>1)</sup>	3044401	40	40	40	200	12800	0,054
ANPS204625 <sup>1)</sup>	3000301	40	60	25	200	12800	0,040
ANPS204460-B <sup>1)</sup>	3044600	40	40	60	200	11400	0,070
ANPS206625 <sup>1)</sup>	3000501	60	60	25	200	12800	0,046
ANPS206640 <sup>1)</sup>	3066401	60	60	40	100	11100	0,071
ANPS206650-B <sup>1)</sup>	3066500	60	60	50	150	8550	0,090
ANPS206660-B <sup>1)</sup>	3066600	60	60	60	100	7200	0,107
ANPS206680 <sup>1)</sup>	3066801	60	60	80	100	5400	0,140
ANPS208860-B <sup>1)</sup>	3088600	80	80	60	100	5000	0,140
ANPS208880 <sup>1)</sup>	3088801	80	80	80	50	4950	0,186
BNV33	0761500	61	33	180	50	2700	0,203
AB6983	AB6983	69	83	300	20	960	1,290
AB36125	AB36125	36	125	247	25	1200	0,636

1) Currently without ETA-CE / Momentálně bez ETA-CE / In prezent nu ETA-CE

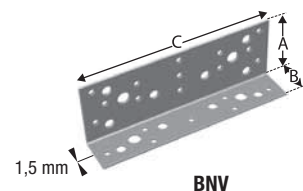
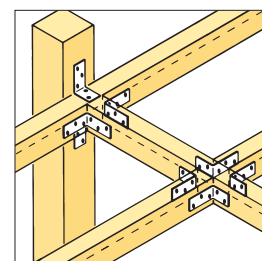

ETA 07/0055

It. no. NEW č. p. NOVÉ nu. art. NOU	It. no. OLD č. p. STARÉ nu. art. VECHI	Dimensions/Rozměry/Dimensi- uni [mm]			pcs. / package ks./bal. buc./pac.	pallet / pcs. pal./ks palet/buc.	kg / pcs. kg/ks. kg/buc.
		A	B	C			
KNAG90-B	1909000	90	90	65	50	2000	0,296
KNAG130-B	1913000	125	125	80	50	1600	0,440
KNAG170-B	1917000	160	160	95	25	950	0,730
KNAG210-B	1921000	200	200	100	15	720	1,070

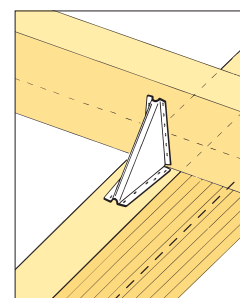
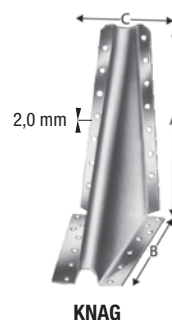



ETA 06/0270

It. no. NEW č. p. NOVÉ nu. art. NOU	It. no. OLD č. p. STARÉ nu. art. VECHI	Dimensions/Rozměry/Dimen- siuni [mm]				pcs. / package ks./bal. buc./pac.	pallet / pcs. pal./ks palet/buc.	kg / pcs. kg/ks. kg/buc.
		A	B	C	D			
BSN36/142	0320201	36	142	40	80	50	1600	0,380
BSN40/99-B	0300300	40	99	37	72	50	2000	0,250
BSN40/110	0310301	40	110	37	72	50	2000	0,270
BSN40/140-B	0320300	40	140	40	80	50	1600	0,380
BSN45/96	0300601	45	96	37	72	50	2000	0,250
BSN45/105	0310601	45	105	37	72	50	2000	0,270
BSN45/137	0320401	45	137	40	80	50	1600	0,380
BSN45/167	0330101	45	167	40	80	40	1280	0,433
BSN45/197	0340201	45	197	42	87	25	800	0,580
BSN48/95	0300701	48	95	37	72	50	2000	0,250
BSN48/136	0320501	48	136	40	80	50	1600	0,380
BSN48/166	0330201	48	166	40	80	40	1280	0,433
BSN48/226-B	0350100	48	226	39	85	25	800	0,650
BSN51/93	0300901	51	93	37	72	50	2000	0,250
BSN51/105	0310901	51	105	37	72	50	2000	0,270
BSN51/135	0320601	51	135	40	80	50	1600	0,380
BSN51/164	0330301	51	164	40	80	40	1280	0,433
BSN51/195	0340301	51	195	42	87	25	800	0,580
BSN60/100-B	0311200	60	100	37	72	50	2000	0,270
BSN60/130-B	0320900	60	130	40	80	50	1600	0,380
BSN60/160-B	0330600	60	160	40	80	40	1280	0,433
BSN60/190-B	0340600	60	190	42	87	25	800	0,580
BSN60/220-B	0350300	60	220	40	80	25	800	0,650
BSN64/98	0311501	64	98	37	72	50	2000	0,270
BSN64/128-B	0321200	64	128	40	80	50	1600	0,380
BSN70/125	0321501	70	125	40	80	50	1600	0,380
BSN70/155-B	0330700	70	155	40	80	40	1280	0,433
BSN73/124	0321601	73	124	40	80	50	1600	0,380
BSN73/153	0330801	73	153	40	80	40	1280	0,433
BSN73/183-B	0340800	73	183	42	87	25	800	0,580
BSN76/120	0321801	76	120	40	80	50	1600	0,380
BSN76/152	0330901	76	152	40	80	40	1280	0,433
BSN80/120-B	0322100	80	120	40	80	50	1600	0,380
BSN80/150	0331201	80	150	40	80	40	1280	0,433
BSN80/180-B	0341200	80	180	42	87	25	800	0,580
BSN80/210-B	0350600	80	210	39	85	25	600	0,650
BSN90/145	0331501	90	145	40	80	40	1280	0,433
BSN98/141	0331701	98	141	40	80	40	1280	0,433
BSN100/90	0322401	100	90	40	80	50	1600	0,343
BSN100/140-B	0331800	100	140	40	80	40	960	0,433
BSN100/170-B	0341500	100	170	42	87	25	800	0,580
BSN100/200-B	0350900	100	200	39	85	25	600	0,650
BSN115/162-B	0341800	115	162	42	87	25	800	0,580
BSN115/190-B	0351200	115	190	42	87	25	600	0,650
BSN120/119-B	0361200	120	119	40	80	25	800	0,467
BSN120/160-B	0342100	120	160	42	87	25	800	0,580
BSN120/190-B	0351500	120	190	39	85	25	600	0,650
BSN127/126-B	0332100	127	126	40	80	40	1280	0,421
BSN127/186-B	0351800	127	186	42	87	25	600	0,650
BSN140/139-B	0371400	140	139	40	80	25	800	0,535
BSN140/180-B	0352100	140	180	39	85	25	600	0,650
BSN150/145-B	0342400	150	145	42	87	25	800	0,545

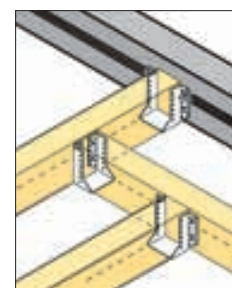
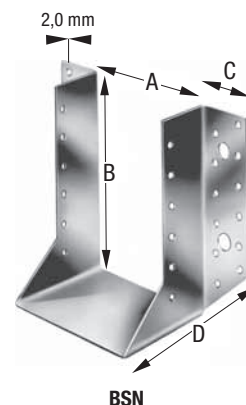



ETA 06/0270

lt. no. NEW č. p. NOVÉ nu. art. NOU	lt. no. OLD č. p. STARÉ nu. art. VECHI	Dimensions/Rozměry/Dimensiuni [mm]				pcs. / package ks./bal. buc./pac.	pallet / pcs. pal./ks palet/buc.	kg / pcs. kg/ks. kg/buc.
		A	B	C	D			
BSI40/110-B	0410300	40	110	37	72	50	2000	0,250
BSI45/96	0400601	45	96	37	72	50	2000	0,200
BSI48/95	0400301	48	95	37	72	50	2000	0,200
BSI48/136	0420501	48	136	40	80	50	2000	0,320
BSI48/166	0430201	48	166	40	80	40	1600	0,370
BSI60/100-B	0411200	60	100	37	72	50	2000	0,257
BSI60/160-B	0430600	60	160	40	80	40	1600	0,390
BSI64/98-B	0411500	64	98	37	72	50	2000	0,257
BSI64/128-B	0421200	64	128	40	80	50	1600	0,340
BSI70/125-B	0421500	70	125	40	80	50	1600	0,340
BSI73/124	0421601	73	124	40	80	50	1600	0,340
BSI73/153-B	0430800	73	153	40	80	40	1280	0,390
BSI76/120-B	0421800	76	120	40	80	50	1600	0,380
BSI80/120-B	0422100	80	120	40	80	50	1600	0,380
BSI80/150-B	0431200	80	150	40	80	40	1280	0,430
BSI80/180-B	0441200	80	180	42	87	25	800	0,580
BSI80/210-B	0450600	80	210	39	85	25	800	0,650
BSI90/145-B	0431500	90	145	40	80	40	1280	0,430
BSI98/141	0431701	98	141	40	80	40	1280	0,430
BSI100/90-B	0422400	100	90	40	80	50	1600	0,343
BSI100/140-B	0431800	100	140	40	80	40	1280	0,430
BSI100/170-B	0441500	100	170	42	87	25	1000	0,580
BSI100/200-B	0450900	100	200	39	85	25	800	0,650
BSI115/162-B	0441800	115	162	42	87	25	1000	0,580
BSI115/190-B	0451200	115	190	42	87	25	800	0,650
BSI120/119-B	0461200	120	119	40	80	25	1000	0,467
BSI120/160-B	0442100	120	160	42	87	25	800	0,580
BSI120/190-B	0451500	120	190	39	85	25	800	0,650
BSI140/139-B	0471400	140	139	40	80	25	800	0,535
BSI140/180-B	0452100	140	180	39	85	25	800	0,650

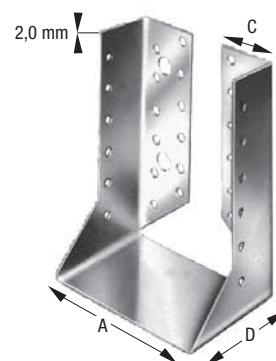

**BSI**

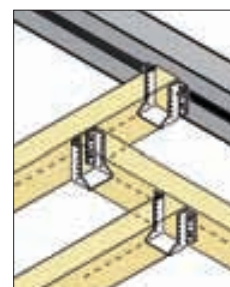



ETA 06/0270

It. no. NEW č. p. NOVÉ nu. art. NOU	It. no. OLD č. p. STARÉ nu. art. VECHI	Dimensions/Rozměry/Dimensiuni [mm]				pcs. / package ks./bal. buc./pac.	pallet / pcs. pal./ks palet/buc.	kg / pcs. kg/ks. kg/buc.
		A	B	C	D			
SBE40/95	0901001	40	95	30	55	70	1680	0,170
SBE40/110	0911001	40	110	30	55	70	1680	0,195
SBE40/140	0921001	40	140	30	55	50	1200	0,240
SBE45/93	0901301	45	93	30	55	70	1680	0,170
SBE45/108	0911301	45	108	30	55	70	1680	0,195
SBE45/138	0921301	45	138	30	55	50	1200	0,240
SBE45/168	0931301	45	168	30	55	30	720	0,290
SBE48/91	0901601	48	91	30	55	70	1680	0,170
SBE48/136	0921601	48	136	30	55	50	1200	0,240
SBE48/166	0931601	48	166	30	55	30	720	0,290
SBE51/90	0901901	51	90	30	55	70	1680	0,170
SBE51/135	0921901	51	135	30	55	50	1200	0,240
SBE60/100	0912201	60	100	30	55	70	1680	0,195
SBE60/130	0922201	60	130	30	55	50	1200	0,240
SBE60/160	0932201	60	160	30	55	30	720	0,290
SBE64/98	0912501	64	98	30	55	70	1680	0,195
SBE64/128	0922501	64	128	30	55	50	1200	0,240
SBE70/125	0922801	70	125	30	55	50	1200	0,240
SBE70/155	0932801	70	155	30	55	30	720	0,290
SBE73/154	0933101	73	154	30	55	30	720	0,290
SBE76/122	0923401	76	122	30	55	50	1200	0,240
SBE76/152	0933401	76	152	30	55	30	720	0,290
SBE80/120	0923701	80	120	30	55	50	1200	0,240
SBE80/150	0933701	80	150	30	55	30	720	0,290
SBE90/145	0934001	90	145	30	55	30	720	0,290
SBE98/141	0934301	98	141	30	55	30	720	0,290
SBE100/140	0934601	100	140	30	55	30	720	0,290

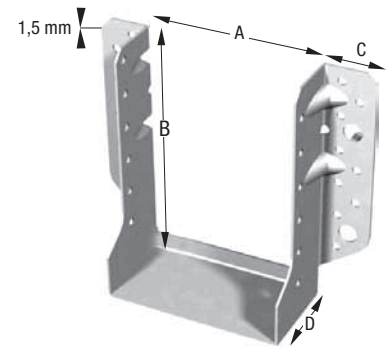

**SBE**

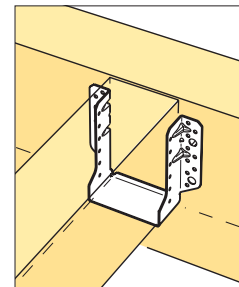





ETA 06/0270

It. no. NEW č. p. NOVÉ nu. art. NOU	Dimensions/Rozměry/Dimensiuni [mm]				pcs. / package ks./bal. buc./pac.	pallet / pcs. pal./ks palet/buc.	kg / pcs. kg/ks. kg/buc.
	A	B	C	D			
SBG40/110	40	110	27,5	55	70	1680	0,170
SBG45/108	45	108	27,5	55	70	1680	0,170
SBG45/137	45	137	27,5	55	50	1200	0,210
SBG51/105	51	105	27,5	55	70	1680	0,170
SBG51/135	51	135	27,5	55	50	1200	0,210
SBG51/164	51	164	27,5	55	30	720	0,260
SBG60/100	60	100	27,5	55	70	1680	0,170
SBG60/130	60	130	27,5	55	50	1200	0,210
SBG60/160	60	160	27,5	55	30	720	0,260
SBG60/190	60	190	27,5	55	25	600	0,290
SBG60/220	60	220	27,5	55	25	600	0,320
SBG70/125	70	125	27,5	55	50	1200	0,210
SBG70/155	70	155	27,5	55	30	720	0,260
SBG80/120	80	120	27,5	55	50	1200	0,210
SBG80/150	80	150	27,5	55	30	720	0,260
SBG80/180	80	180	27,5	55	25	600	0,290
SBG80/210	80	210	27,5	55	25	600	0,320
SBG90/145	90	145	27,5	55	30	720	0,260
SBG100/140	100	140	27,5	55	30	720	0,260
SBG100/170	100	170	27,5	55	25	600	0,290
SBG100/200	100	200	27,5	55	25	600	0,320
SBG120/160	120	160	27,5	55	25	600	0,290
SBG120/190	120	190	27,5	55	25	600	0,320
SBG140/180	140	180	27,5	55	25	600	0,320

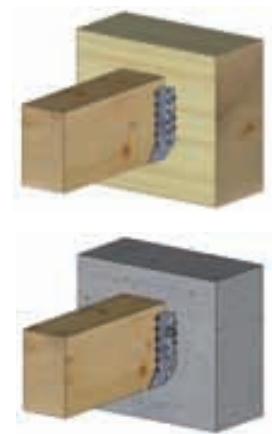
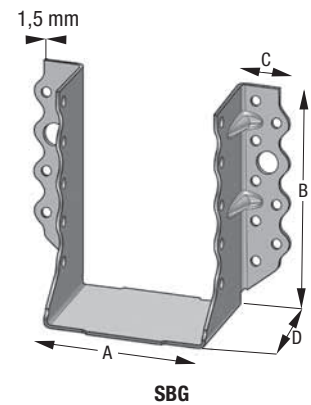



ETA 06/0270

lř. no. NEW ř. p. NOVÉ nu. art. NOU	Dimensions/Rozměry/Dimensiuni [mm]				pcs. / package ks./bal. buc./pac.	pallet / pcs. pal./ks palet/buc.	kg / pcs. kg/ks. kg/buc.
	A	B	C	D			
BSD80/100	80	100	32	52	50	2000	0,358
BSD100/120	100	120	32	52	25	1000	0,360
BSD100/240	100	240	32	52	20	640	0,742
BSD120/180	120	180	32	52	25	800	0,540
BSD120/240	120	240	32	52	20	640	0,768
BSD120/300	120	300	32	52	20	640	0,830
BSD120/320	120	320	32	52	20	640	0,880
BSD140/200	140	200	32	52	25	800	0,600
BSD140/240	140	240	32	52	20	480	0,832
BSD140/260	140	260	32	52	25	600	0,750
BSD140/300	140	300	32	52	20	640	0,850
BSD140/320	140	320	32	52	20	640	0,900
BSD160/160	160	160	32	52	25	800	0,614
BSD160/200	160	200	32	52	20	640	0,717
BSD160/240	160	240	32	52	10	400	0,814
BSD160/260	160	260	32	52	25	600	0,760
BSD160/280	160	280	32	52	10	400	0,922
BSD160/300	160	300	32	52	10	400	0,973
BSD160/320	160	320	32	52	10	320	1,024
BSD180/180	180	180	32	52	20	640	0,691
BSD180/220	180	220	32	52	20	480	0,794
BSD180/280	180	280	32	52	10	400	0,947
BSD180/320	180	320	32	52	20	640	0,930
BSD200/200	200	200	32	52	20	640	0,768
BSD200/240	200	240	32	52	20	640	0,870
BSD200/280	200	280	32	52	20	480	0,850
BSDI80/100	80	100	32	52	50	2000	0,358
BSDI120/240	120	240	32	52	20	640	0,768
BSDI140/200	140	200	32	52	25	800	0,600
BSDI140/240	140	240	32	52	20	640	0,794
BSDI140/260	140	260	32	52	25	600	0,750
BSDI140/300	140	300	32	52	20	640	0,850
BSDI160/160	160	160	32	52	25	800	0,614
BSDI160/200	160	200	32	52	20	640	0,717
BSDI160/260	160	260	32	52	25	800	0,760
BSDI160/280	160	280	32	52	20	640	0,810
BSDI160/300	160	300	32	52	20	640	0,860
BSDI180/220	180	220	32	52	20	640	0,794
BSDI200/200	200	200	32	52	20	640	0,768
BSDI200/240	200	240	32	52	20	640	0,870

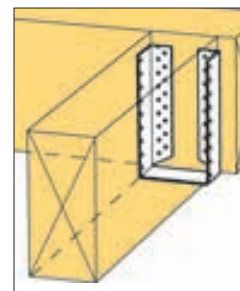
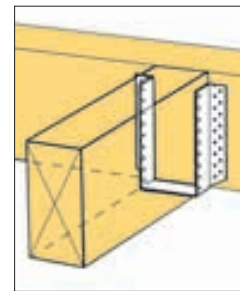
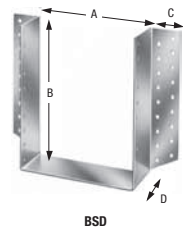



ETA 06/0270

It. no. NEW č. p. NOVÉ nu. art. NOU	It. no. OLD č. p. STARÉ nu. art. VECHI	Dimensions/Rozměry/Dimensi- uni [mm]				pcs. / package ks./bal. buc./pac.	pallet / pcs. pal./ks palet/buc.	kg / pcs. kg/ks. kg/buc.
		A	B	C	D			
BSN2P30/98-B	0301000	30	98	37,5	73	20	1080	0,416
BSN2P30/152-B	0301100	30	152	40,0	80	20	1080	0,425
BSN2P30/182-B	0301200	30	182	42,0	87	20	1080	0,678

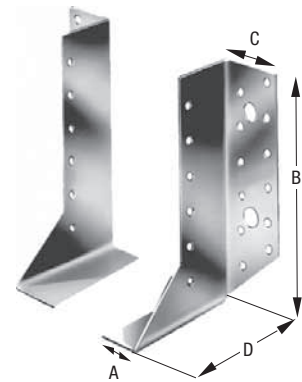

**BSN2P**

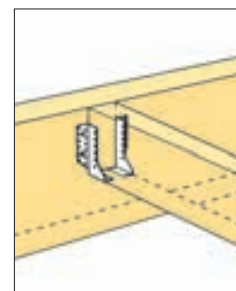

ETA 07/0150

It. no. NEW č. p. NOVÉ nu. art. NOU	It. no. OLD č. p. STARÉ nu. art. VECHI	Dimensions/Rozměry/Dimensi- uni [mm]				pcs. / package ks./bal. buc./pac.	pallet / pcs. pal./ks palet/buc.	kg / pcs. kg/ks. kg/buc.
		A	B	C	D			
BSIL90/195	0620001	90	195	42	87	25	1000	0,640
BSIL90/235	0620201	90	235	39	85	25	800	0,769
BSIL100/190	0620601	100	190	42	87	25	1000	0,640
BSIL100/230	0621001	100	230	39	85	25	800	0,768
BSIL115/223	0620401	115	223	39	85	25	800	0,756
BSIL120/180	0620801	120	180	42	87	25	1000	0,640
BSIL120/220	0621201	120	220	39	85	25	800	0,768

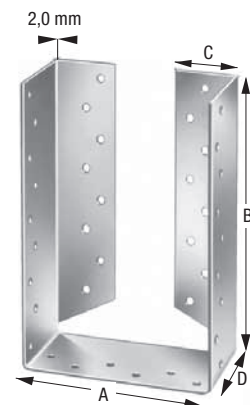

**BSIL**

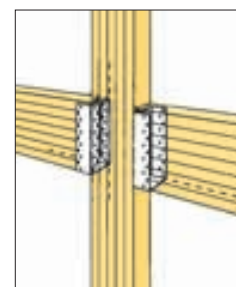



ETA 07/0150

It. no. NEW č. p. NOVÉ nu. art. NOU	It. no. OLD č. p. STARÉ nu. art. VECHI	Dimensions/Rozměry/Dimensiuni [mm]				pcs. / package ks./bal. buc./pac.	pallet / pcs. pal./ks palet/buc.	kg / pcs. kg/ks. kg/buc.
		A	B	C	D			
BSS60/90-B	0505000	60	90	58	48	25	1000	0,300
BSS60/110-B	0507000	60	110	58	48	25	1000	0,360
BSS80/110-B	0510000	80	110	58	48	25	1000	0,370
BSS80/130-B	0518000	80	130	58	48	25	1000	0,440
BSS80/150-B	0528000	80	150	58	48	25	1000	0,520
BSS100/130-B	0524000	100	130	58	48	25	1000	0,448
BSS100/150-B	0533000	100	150	58	48	25	800	0,504
BSS100/170-B	0538000	100	170	58	48	25	800	0,585
BSS100/190-B	0538500	100	190	58	48	25	800	0,650
BSS120/170-B	0543000	120	170	58	48	25	800	0,588
BSS120/190-B	0553000	120	190	58	48	25	800	0,640
BSS120/210-B	0557000	120	210	58	48	25	800	0,712
BSS120/230-B	0563000	120	230	58	48	25	800	0,784
BSS140/150-B	0539000	140	150	58	48	25	800	0,585
BSS160/190-B	0559000	160	190	58	48	25	800	0,680

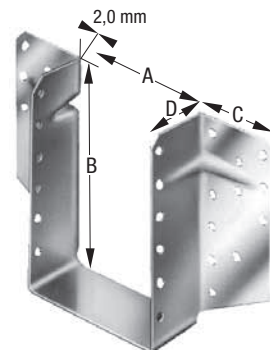

**BSS**

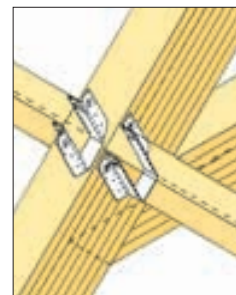

ETA 07/0150

It. no. NEW č. p. NOVÉ nu. art. NOU	It. no. OLD č. p. STARÉ nu. art. VECHI	Dimensions/Rozměry/Dimensiuni [mm]				pcs. / package ks./bal. buc./pac.	pallet / pcs. pal./ks palet/buc.	kg / pcs. kg/ks. kg/buc.
		A	B	C	D			
GSE120/390/2,5	GSE900/120/2,5	120	390	42	110	11	–	1,980
GSE140/380/2,5	GSE900/140/2,5	140	380	42	110	11	–	1,980
GSE140/410/2,5	GSE960/140/2,5	140	410	42	110	10	–	2,110
GSE140/440/2,5	GSE1020/140/2,5	140	440	42	110	9	–	2,240
GSE160/370/2,5	GSE900/160/2,5	160	370	42	110	11	–	1,980
GSE160/400/2,5	GSE960/160/2,5	160	400	42	110	10	–	2,110
GSE160/430/2,5	GSE1020/160/2,5	160	430	42	110	9	–	2,240

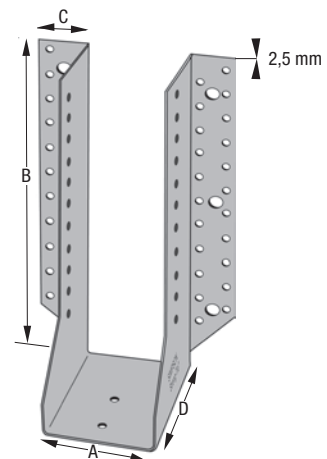

**GSE**



ETA 07/0125

It. no. NEW č. p. NOVÉ nu. art. NOU	It. no. OLD č. p. STARÉ nu. art. VECHI	Dimensions/Rozměry/Dimensi- uni [mm]			pcs. / package ks./bal. buc./pac.	pallet / pcs. pal./ks palet/buc.	kg / pcs. kg/ks. kg/buc.
		A	B	C			
BTN90-B	3409000	90	103	46	25	1200	0,520
BTN120-B	3412000	120	103	46	25	1200	0,672
BTN160-B	3416000	160	103	46	20	960	0,904
BTN200-B	3420000	200	103	46	15	720	1,120
BTN240-B	3424000	240	103	46	15	720	1,347
BT4-90-B	3440900	90	103	62	25	1200	0,543
BT4-120-B	3441200	120	103	62	25	1200	0,716
BT4-160-B	3441600	160	103	62	20	960	0,953
BT4-200-B	3442000	200	103	62	15	570	1,180
BT4-240-B	3442400	240	103	62	15	570	1,423
BTALU90-B	3450900	86	103	62	25	1200	0,225
BTALU120-B	3451200	116	103	62	25	1200	0,303
BTALU160-B	3451600	156	103	62	25	950	0,406
BTALU200-B	3452000	196	103	62	15	570	0,509
BTALU240-B	3452400	236	103	62	15	570	0,609
BTALU3000-B	3450300	3000	103	62	1	-	7,980

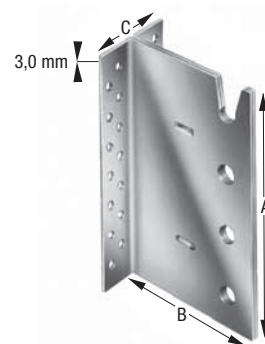

BTN

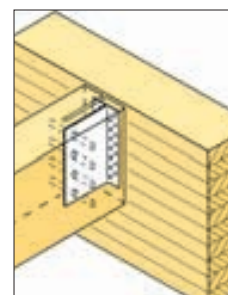

BTALU



ETA 07/0125

It. no. NEW č. p. NOVÉ nu. art. NOU	It. no. OLD č. p. STARÉ nu. art. VECHI	Dimensions/Rozměry/Dimensi- uni [mm]			pcs. / package ks./bal. buc./pac.	pallet / pcs. pal./ks palet/buc.	kg / pcs. kg/ks. kg/buc.
		A	B	C			
TU12-B	3431200	96	98	40	50	1600	0,262
TU16-B	3431600	134	105	60	50	1600	0,388
TU20-B	3432000	174	105	60	25	800	0,528
TU24-B	3432400	214	105	60	25	800	0,664
TU28-B	3432800	254	105	60	20	640	0,800
TUS12-B	3431230	96	98	40	1	-	0,262
TUS16-B	3431630	134	105	60	1	-	0,390
TUS20-B	3432030	174	105	60	1	-	0,530
TUS24-B	3432430	214	105	60	1	-	0,660
TUS28-B	3432830	254	105	60	1	-	0,800

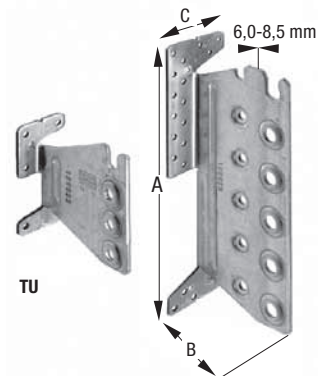

TU

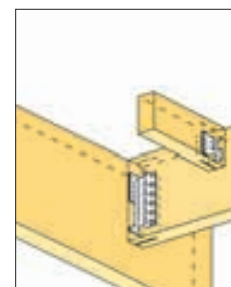



ETA 07/0245

It. no. NEW č. p. NOVÉ nu. art. NOU	It. no. OLD č. p. STARÉ nu. art. VECHI	Dimensions/Rozměry/Dimensi- uni [mm]				pcs. / package ks./bal. buc./pac.	pallet / pcs. pal./ks palet/buc.	kg / pcs. kg/ks. kg/buc.
		A	B	C	D			
ETB90-B	3470900	90	60	58	69	25	2150	0,103
ETB120-B	3471200	121	60	85	95	25	2150	0,137
ETB160-B	3471600	166	60	95	130	25	2000	0,192
ETB190-B	3471900	195	75	138	165	25	1200	0,274
ETB230-B	3472300	230	75	138	200	25	1200	0,342

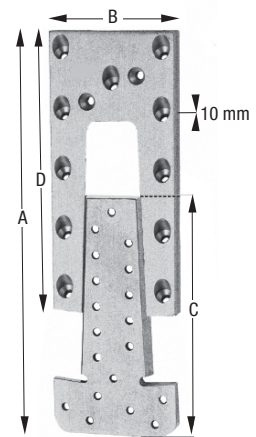

**ETB**

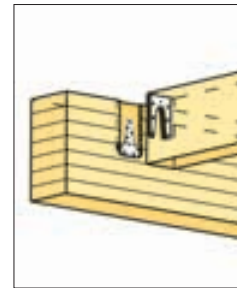

ETA 07/0245

It. no. NEW č. p. NOVÉ nu. art. NOU	It. no. OLD č. p. STARÉ nu. art. VECHI	Dimensions/Rozměry/Dimensi- uni [mm]			pcs. / package ks./bal. buc./pac.	pallet / pcs. pal./ks palet/buc.	kg / pcs. kg/ks. kg/buc.
		A	B	C			
EL30-B	3480300	30	55	120	25	2025	0,117
EL40-B	3480400	40	55	120	25	2025	0,162
EL60-B	3480600	60	55	120	25	2025	0,242
EL80-B	3480800	80	55	120	25	1300	0,324
EL100-B	3481000	100	55	120	25	1300	0,405
ELS30-B	3482300	30	178	178	25	4500	0,136
ELS40-B	3482400	40	178	178	25	4500	0,170
ELS60-B	3482600	60	178	178	25	1700	0,263
ELS80-B	3482800	80	178	178	25	1700	0,349
ELS100-B	3483000	100	178	178	25	1600	0,434

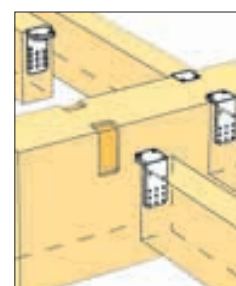
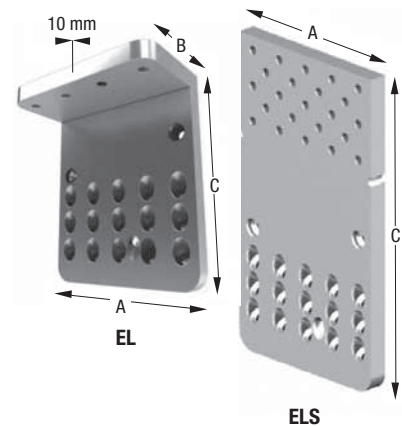



ETA 07/0290

It. no. NEW č. p. NOVÉ nu. art. NOU	It. no. OLD č. p. STARÉ nu. art. VECHI	Dimensions/Rozměry/Dimensi- uni [mm]		pcs. / package ks./bal. buc./pac.	pallet / pcs. pal./ks palet/buc.	kg / pcs. kg/ks. kg/buc.
		A	B			
ATF55/110-B	3475100	55	110	20	1320	0,420
ATF55/150-B	3475500	55	150	20	1320	0,570
ATF55/190-B	3475900	55	190	20	1320	0,710
ATF75/150-B	3477500	75	150	10	660	0,790
ATF75/190-B	3477900	75	190	10	660	0,990



**ATF**

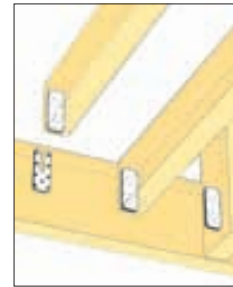

Beam coupling/Trémové spojky/Fascicul de cuplare

**JANEBO®**

It. no. NEW č. p. NOVÉ nu. art. NOU	It. no. OLD č. p. STARÉ nu. art. VECHI	pcs. / package ks./bal. buc./pac.	pallet / pcs. pal./ks palet/buc.	kg / pcs. kg/ks. kg/buc.
JHH140	8061400	1	-	2,100
JHH200	8062000	1	-	2,500
JHH260	8062600	1	-	3,200
JHH320	8063200	1	-	3,700
JHH380	8063800	1	-	4,500
JHD1-20	8060100	1	-	0,800
JHD1-24	8060200	1	-	1,000
JHD1-36	8060300	1	-	1,600
JHD1-48	8060400	1	-	2,300
JHD1-60	8060500	1	-	3,000

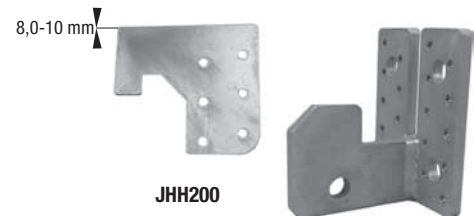

**JHH200**

**JHD 1-20**

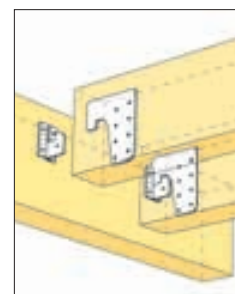

It. no. NEW č. p. NOVÉ nu. art. NOU	It. no. OLD č. p. STARÉ nu. art. VECHI	Dimensions/Rozměry/Dimensiuni [mm]				pcs. / package ks./bal. buc./pac.	pallet / pcs. pal./ks palet/buc.	kg / pcs. kg/ks. kg/buc.
		A	B	C	D			
B0176/60	8074000	176	60	60	45	1	–	1,000
B0176/80	8074100	176	60	80	45	1	–	1,300
B0176/100	8074200	176	60	100	45	1	–	1,700
B0196/60	8074300	196	60	60	45	1	–	1,100
B0196/80	8074400	196	60	80	45	1	–	1,400
B0196/100	8074500	196	60	100	45	1	–	1,800
B0216/60	8074600	216	60	60	45	1	–	1,200
B0216/80	8074700	216	60	80	45	1	–	1,500
B0216/100	8074800	216	60	100	45	1	–	1,900
B0236/60	8074900	236	60	60	45	1	–	1,300
B0236/80	8075000	236	60	80	45	1	–	1,600
B0236/100	8075100	236	60	100	45	1	–	2,000

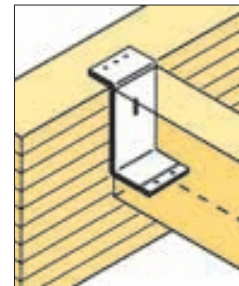
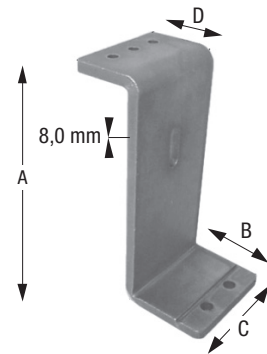

It. no. NEW č. p. NOVÉ nu. art. NOU	It. no. OLD č. p. STARÉ nu. art. VECHI	Dimensions/Rozměry/Dimensi- uni [mm]			pcs. / package ks./bal. buc./pac.	pallet / pcs. pal./ks palet/buc.	kg / pcs. kg/ks. kg/buc.
		A	B	C			
TALU3000-B	3460300	20	203	3000	1	–	10,560

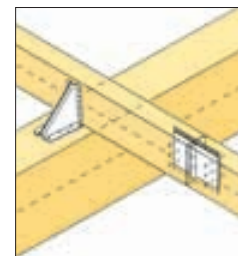
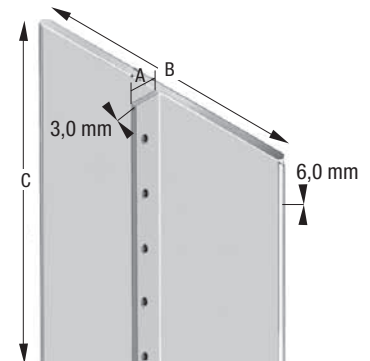



It. no. NEW č. p. NOVÉ nu. art. NOU	It. no. OLD č. p. STARÉ nu. art. VECHI	pcs. / package ks./bal. buc./pac.	pallet / pcs. pal./ks palet/buc.	kg / pcs. kg/ks. kg/buc.
MOET	3490300	1	–	3,900
ETTP90-160	ETTP90-160	1	–	1,038
ETTP190-230	ETTP190-230	1	–	1,460
MOEL	3490400	1	–	3,350
MOATF55	3490500	1	–	1,550
MOATF75	3490600	1	–	1,450
FRATF55	3490700	1	–	1,450
FRATF75	3490800	1	–	1,400
BTBS12	3490100	1	–	6,600
BTBS8	3490200	1	–	1,600

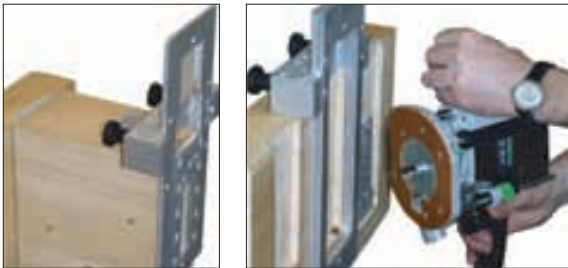

ETB

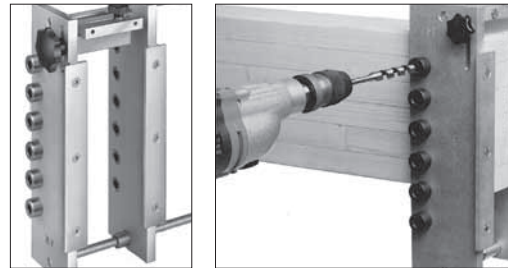

Joist and support bracket/Skrytá trémová botka/Suport grinda

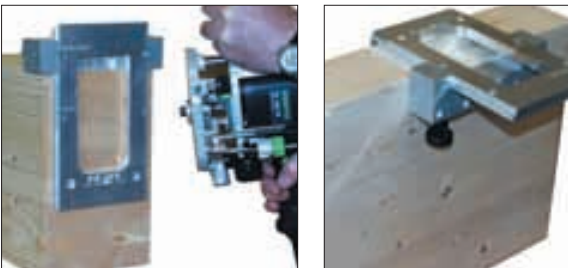

EL

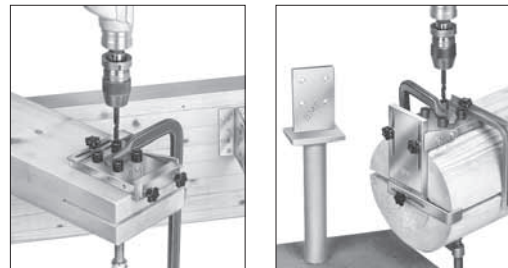

for/pro/pentru: joist and support bracket 90 / skrytá trémová botka 90 / suport grinda 90

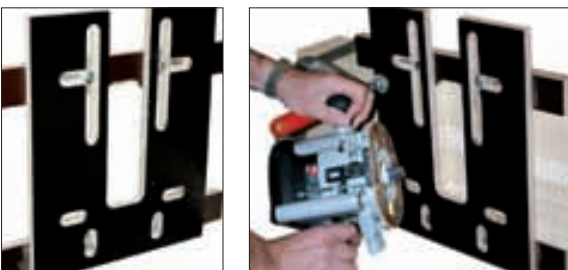

ATF



ETA-04/0042 + 06/0034

It. no. NEW č. p. NOVÉ nu. art. NOU	Intended for / Určeno pro / Destinate pentru	Dimensions/ Rozměry/Dimensiuni [mm]			pcs. / package ks./bal. buc./pac.	pallet / pcs. pal./ks palet/buc.	kg / pcs. kg/ks. kg/buc.	
		A	B	C				
<b>With mounting arm/S montážním ramenem / Montare bratul</b>								
ITSE239/61	MTT359.5	ITT359.5	61	239	54	25	750	0,310
ITSE299/61	MIT3511.88		61	299	54	25	600	0,340
ITSE299/92	MTT411.88	ITT411.88	92	299	54	20	600	0,390
ITSE359/61	MIT3514	ITT3514	61	359	54	20	375	0,440
ITSE359/92	MIT414	ITT414	92	359	54	15	450	0,467
<b>Without mounting arm/Bez montážního ramene/Fara montaj brat</b>								
IUSE239/61	IUT3510	U3510/14	61	239	51	30	1800	0,262
IUSE299/61	IUT3512	U3510/14	61	299	51	25	1250	0,338
IUSE299/92	IUT412	HU410	92	299	51	30	900	0,329
IUSE359/61	IUT3514	U3510/14	61	359	51	30	1500	0,393
IUSE359/92	IUT414	HU416	92	359	51	30	1500	0,386
IUSE399/61	IUT3514		61	399	51	25	1500	0,420
IUSE399/92	IUT380/91	HU416	92	399	51	30	900	0,424
<b>Inclined And oblique/Nakloněné a šikmé/Inclinat si oblice</b>								
LSSUI25			45	-	216	25	900	0,360
LSSUI35			60	146	216	25	900	0,400
LSSU410			90	230	216	25	1000	0,660
<b>Drawstring/Stahovací šňůrkou/cordon</b>								
LSTA21			32	-	533	50	9900	0,120

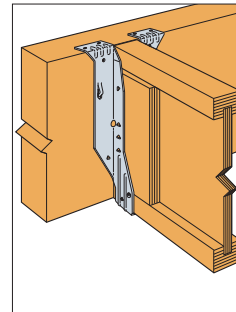
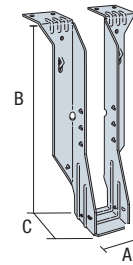

ITSE

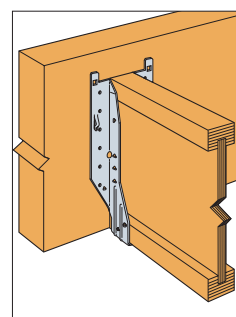
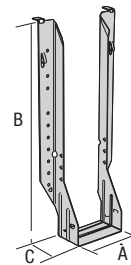

IUSE

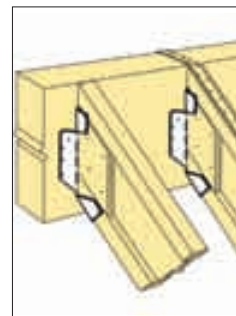
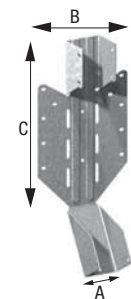

LSSU





ETA 07/0137

It. no. NEW č. p. NOVÉ nu. art. NOU	It. no. OLD č. p. STARÉ nu. art. VECHI	Dimensions/Rozměry/Dimensi- uni [mm]				pcs. / package ks./bal. buc./pac.	pallet / pcs. pal./ks palet/buc.	kg / pcs. kg/ks. kg/buc.
		A	B	C	D			
UNI96L-B	0130000	96	34	35	46	100	4500	0,080
UNI96R-B	0130100	96	34	35	46	100	4500	0,080
UNI100L-B	0120000	100	52,5	62,5	47,5	100	3600	0,151
UNI100R-B	0120100	100	52,5	62,5	47,5	100	3600	0,151
UNI130L-B	0110000	130	61,5	62,5	58	50	1600	0,244
UNI130R-B	0110100	130	61,5	62,5	58	50	1600	0,244
UNI190L-B	0100000	192	49,5	49,5	96	50	1800	0,204
UNI190R-B	0100200	192	49,5	49,5	96	50	1800	0,204



UNI96L

UNI96R

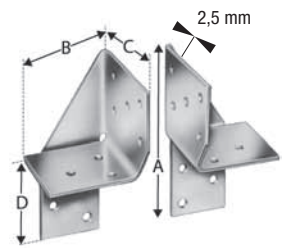

UNI100L

UNI100R

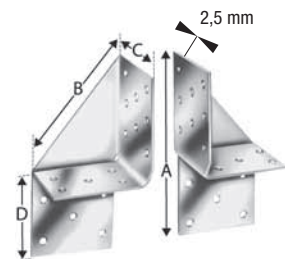

UNI130L

UNI130R

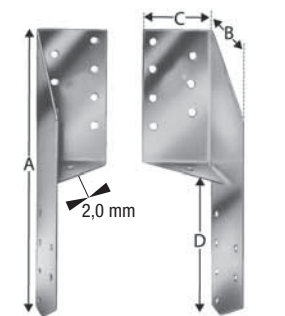

UNI190L

UNI190R

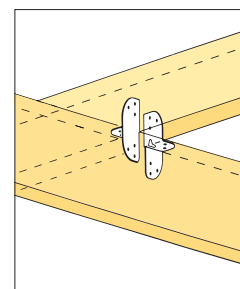



ETA 07/0137

It. no. NEW č. p. NOVÉ nu. art. NOU	It. no. OLD č. p. STARÉ nu. art. VECHI	Dimensions/Rozměry/Dimen- siuni [mm]		pcs. / package ks./bal. buc./pac.	pallet / pcs. pal./ks palet/buc.	kg / pcs. kg/ks. kg/buc.
		A	B			
SPF170L	0217001	170	34,5	100	9600	0,096
SPF170R	0217101	170	34,5	100	9600	0,096
SPF210L	0221001	210	34,5	100	7200	0,134
SPF210R	0221101	210	34,5	100	7200	0,134
SPF250L	0225001	250	34,5	100	5100	0,167
SPF250R	0225101	250	34,5	100	5100	0,167
SPF290L	0229001	290	34,5	100	5100	0,207
SPF290R	0229101	290	34,5	100	5100	0,207
SPF330L	0233001	330	34,5	50	3600	0,243
SPF330R	0233101	330	34,5	50	3600	0,243
SPF370L	0237001	370	34,5	50	3600	0,279
SPF370R	0237101	370	34,5	50	3600	0,279
SPF170LR-B	0217200	170	34,5	40 Satz	9600	0,096
SPF210LR-B	0221200	210	34,5	40 Satz	7680	0,134

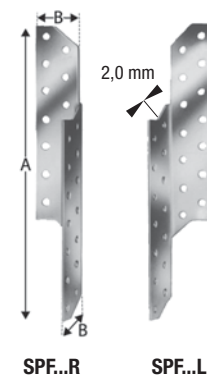

SPF...R      SPF...L

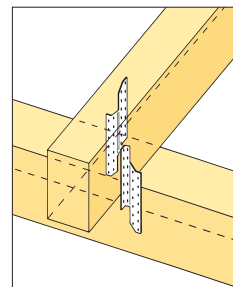

ETA 07/0137

It. no. NEW č. p. NOVÉ nu. art. NOU	It. no. OLD č. p. STARÉ nu. art. VECHI	Dimensions/Rozměry/Dimen- siuni [mm]		pcs. / package ks./bal. buc./pac.	pallet / pcs. pal./ks palet/buc.	kg / pcs. kg/ks. kg/buc.
		A	B			
PFE170E-B	3217000	170	20	40 set / sada / rata	9600	0,076
PFE210E-B	3221000	210	20	40 set / sada / rata	7680	0,106

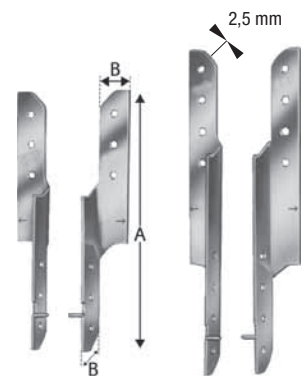

PFE170

PFE210

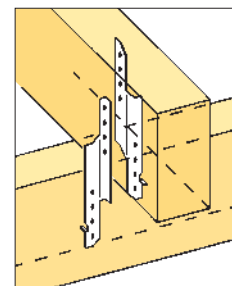



ETA 07/0137

It. no. NEW č. p. NOVÉ nu. art. NOU	It. no. OLD č. p. STARÉ nu. art. VECHI	Dimensions/Rozměry/Dimensiuni [mm]		pcs. / package ks./bal. buc./pac.	pallet / pcs. pal./ks palet/buc.	kg / pcs. kg/ks. kg/buc.
		A	B			
PFU170-B	3257000	170	30	100	6400	0,076
PFU210	3261001	210	30	100	5700	0,094
PFU250-B	3265000	250	30	100	5700	0,113

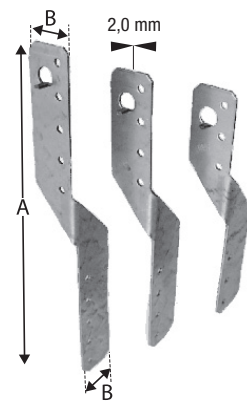

PFU

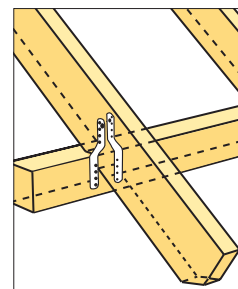

Top batten bracket/Úchytka hřebenové latě/Ancora tip furca

**TOP / TOL**

It. no. NEW č. p. NOVÉ nu. art. NOU	It. no. OLD č. p. STARÉ nu. art. VECHI	Dimensions/Rozměry/Dimensiuni [mm]					pcs. / package ks./bal. buc./pac.	pallet / pcs. pal./ks palet/buc.	kg / pcs. kg/ks. kg/buc.
		A	B	C	D	E			
TOP51-B	0280000	285	57	51	20	60	50	1600	0,180
TOL40-B	0284000	253	57	40	20	23	50	1900	0,124
TOL50-B	0285000	248	57	51	20	23	50	1900	0,124

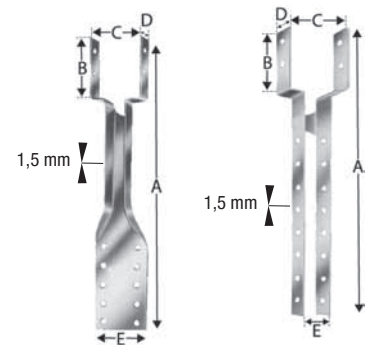

TOP

TOL

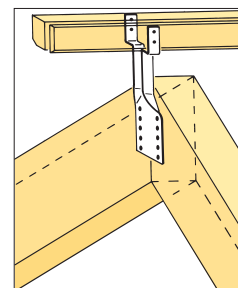



ETA 10/0044

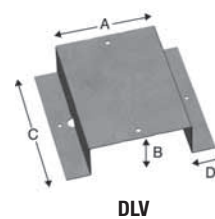

DLV

It. no. NEW č. p. NOVÉ nu. art. NOU	Dimensions/Rozměry/Dimensiuni [mm]				pcs. / package ks./bal. buc./pac.	pallet / pcs. pal./ks palet/buc.	kg / pcs. kg/ks. kg/buc.
	A	B	C	D			
DLV60/40	62	40	140	25	50	1200	0,215
DLV60/50	62	50	140	25	50	1200	0,238
DLV100/40	102	40	140	25	50	1200	0,261

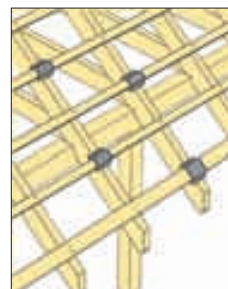

Windbracing strap/Zavětrovací děrovaná páska/Banda de imbinare si banda perforata

**BAN**

It. no. NEW č. p. NOVÉ nu. art. NOU	It. no. OLD č. p. STARÉ nu. art. VECHI	Dimensions/Rozměry/Dimensiuni		pcs. / package ks./bal. buc./pac.	pallet / pcs. pal./ks palet/buc.	kg / pcs. kg/ks. kg/buc.
		A [mm]	B [m]			
BAN10203	2710300	20	3	10	450	0,420
BAN102010	2711000	20	10	10	450	1,525
BAN102025	2721000	20	25	5	240	3,800
BAN152010	2711500	20	10	10	450	2,285
BAN152025	2721500	20	25	5	160	5,130

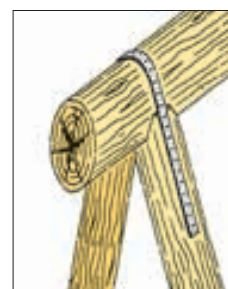
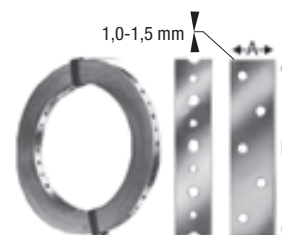

It. no. NEW č. p. NOVÉ nu. art. NOU	It. no. OLD č. p. STARÉ nu. art. VECHI	Dimensions/Rozměry/Dimensi- uni [mm]			pcs. / package ks./bal. buc./pac.	pallet / pcs. pal./ks palet/buc.	kg / pcs. kg/ks. kg/buc.
		A [mm]	B [m]	T [mm]			
BAN202510	2712000	25	10	2,0	4	224	3,980
BAN202525	2725200	25	25	2,0	1	90	9,500
BAN154025	2741400	40	25	1,5	1	30	10,800
BAN154050	2741500	40	50	1,5	1	30	21,600
BAN204025	2741900	40	25	2,0	1	30	14,000
BAN204050	2742000	40	50	2,0	1	30	28,000
BAN304050	2743000	40	50	3,0	1	20	46,200
BAN156050	2761500	60	50	1,5	1	20	35,100
BAN206050	2762000	60	50	2,0	1	20	46,200
BAN158025	2781500	80	25	1,5	1	10	24,000
BAN208025	2782000	80	25	2,0	1	10	29,700

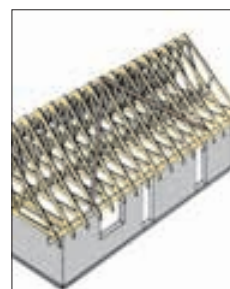
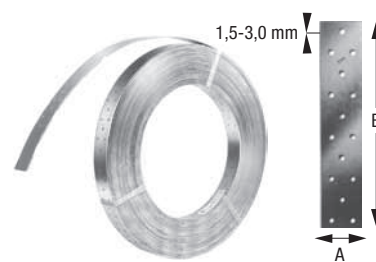

Band unwinder/Odvíječ pásy/Suport pentru rola banda perforata

**BANA**

It. no. NEW č. p. NOVÉ nu. art. NOU	It. no. OLD č. p. STARÉ nu. art. VECHI	pcs. / package ks./bal. buc./pac.	pallet / pcs. pal./ks palet/buc.	kg / pcs. kg/ks. kg/buc.
BANA2-B	2700400	1	6	23,500



BANA2

Windbracing strap/Zavětrovací děrovaná páska/Banda de imbinare si banda perforata

**FBAR / FBPR**

It. no. NEW č. p. NOVÉ nu. art. NOU	It. no. OLD č. p. STARÉ nu. art. VECHI	Dimensions/Rozměry/Di- mensiuni			pcs. / package ks./bal. buc./pac.	pallet / pcs. pal./ks palet/buc.	kg / pcs. kg/ks. kg/buc.
		A [mm]	T [mm]	B [m]			
FBAR12	2712800	12	0,8	10	20	960	0,527
FBAR12B	2712890	12	0,8	10	20	960	0,572
FBAR12W	2712891	12	0,8	10	20	960	0,572
FBAR12R	2712892	12	0,8	10	20	960	0,572
FBAR17	2717800	17	0,8	10	20	760	0,783
FBAR17/25	2717900	17	0,8	25	10	380	1,882
FBAR26-B	2726100	26	1,2	10	10	290	1,646
FBPR16	2716800	16	0,8	10	20	760	0,803
FBPR16B	2716890	16	0,8	10	20	760	0,871
FBPR16W	2716891	16	0,8	10	20	760	0,871
FBPR16R	2716892	16	0,8	10	20	760	0,871

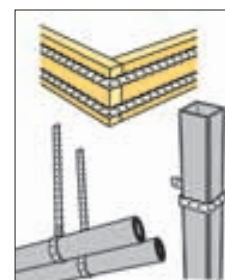
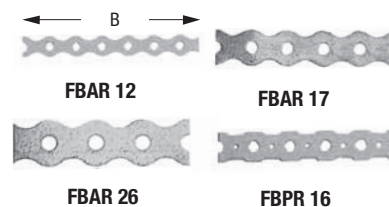

lt. no. NEW č. p. NOVÉ nu. art. NOU	lt. no. OLD č. p. STARÉ nu. art. VECHI	pcs. / package ks./bal. buc./pac.	pallet / pcs. pal./ks palet/buc.	kg / pcs. kg/ks. kg/buc.
BANSTR-B	2700000	3	162	1,000
BANSTRS-B	2700200	1	84	2,300



BANSTR



BANSTRS



ETA 10/0440

lt. no. NEW č. p. NOVÉ nu. art. NOU	lt. no. OLD č. p. STARÉ nu. art. VECHI	Dimensions/Rozměry/Dimensi- uni [mm]			pcs. / package ks./bal. buc./pac.	pallet / pcs. pal./ks palet/buc.	kg / pcs. kg/ks. kg/buc.
		A	B	C			
BNSP25-B	2702500	265-305	25	25	4	344	0,482
BNSP40-B	2704000	300-350	40	28	4	344	0,700
BNSP60-B	2706000	300-350	60	35	4	344	1,325
BNSP80-B	2708000	300-360	80	35	4	256	1,779
BNSP4060B-B	2705000	350-400	60	35	4	260	1,597
BNSP25B-B	2703000	265-305	25	25	4	344	0,528

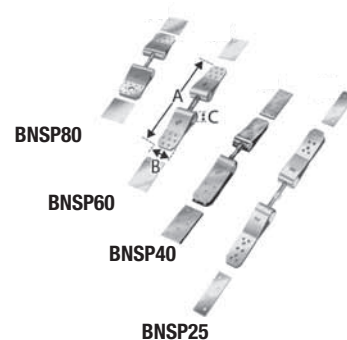

BNSP80

BNSP60

BNSP40

BNSP25



BNSP 25B



BNSP 4060B



BNSP60

BNSP40B





ETA 10/0440

It. no. NEW č. p. NOVÉ nu. art. NOU	It. no. OLD č. p. STARÉ nu. art. VECHI	Dimensions/Rozměry/Dimensiuni [mm]			pcs. / package ks./bal. buc./pac.	pallet / pcs. pal./ks palet/buc.	kg / pcs. kg/ks. kg/buc.
		A	B	C			
BNKK25-B	2792900	125	36	2+2+2=6	4	792	0,167
BNKK40/60-B	2794900	157	60	2+3+2=7	4	792	0,364



**BNKK**

It. no. NEW č. p. NOVÉ nu. art. NOU	It. no. OLD č. p. STARÉ nu. art. VECHI	Dimensions/Rozměry/Dimensiuni [mm]			pcs. / package ks./bal. buc./pac.	pallet / pcs. pal./ks palet/buc.	kg / pcs. kg/ks. kg/buc.
		A	B	T			
BNK25-B	2792600	200	125	2	40	1920	0,290
BNK40/60-B	2794600	290	190	2	10	640	0,575

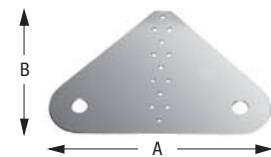

**BNK25**



**BNK40/60**

It. no. NEW č. p. NOVÉ nu. art. NOU	It. no. OLD č. p. STARÉ nu. art. VECHI	Dimensions/Rozměry/Dimensiuni [mm]				pcs. / package ks./bal. buc./pac.	pallet / pcs. pal./ks palet/buc.	kg / pcs. kg/ks. kg/buc.
		A	B	C	T			
BNF25-B	2792000	218	128	15	2	2	288	0,860
BNG25-B	2792300	285	153	50	3	2	160	1,800
BNF40-B	2794000	289	198	15	2	2	114	1,368
BNG60-B	2794300	289	198	69	3	2	134	2,557

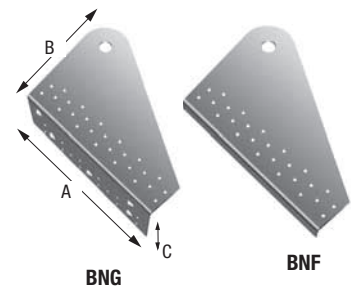

**BNG**

**BNF**



ETA 10/0440

It. no. NEW č. p. NOVÉ nu. art. NOU	It. no. OLD č. p. STARÉ nu. art. VECHI	Dimensions/Rozměry/Dimensiuni [mm]				pcs. / package ks./bal. buc./pac.	pallet / pcs. pal./ks palet/buc.	kg / pcs. kg/ks. kg/buc.
		A	B	C	T			
BNW1	2795000	238	216	40	3+3=6	8	304	2,125
BNW2	2795100	238	216	40	3+3=6	8	304	2,700



**BNW1**

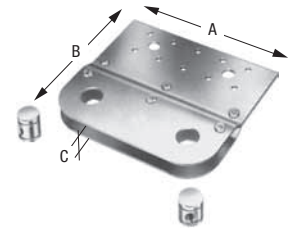

**BNW2**

It. no. NEW č. p. NOVÉ nu. art. NOU	It. no. OLD č. p. STARÉ nu. art. VECHI	Dimensions/Rozměry/Dimensiuni [mm]				pcs. / package ks./bal. buc./pac.	pallet / pcs. pal./ks palet/buc.	kg / pcs. kg/ks. kg/buc.
		A	B	C	I			
BNWA	2795300	140	60	35	165	8	672	0,813



**BNWA**

It. no. NEW č. p. NOVÉ nu. art. NOU	It. no. OLD č. p. STARÉ nu. art. VECHI	Length/Délka/Lungime [mm]		pcs. / package ks./bal. buc./pac.	pallet / pcs. pal./ks palet/buc.	kg / pcs. kg/ks. kg/buc.
		Threaded rod/Závitové tyče/Tija filetata M16 li/re	Tension nut/Napínací matka/Tensiunea piulita			
BNWM 16-B	2795400	140	120	16	864	0,550
BNWM 12-B	2795500	140	120	16	864	0,575



**BNWM**

It. no. NEW č. p. NOVÉ nu. art. NOU	It. no. OLD č. p. STARÉ nu. art. VECHI	Dimensions/Rozměry/Dimensi- uni [mm]			pcs. / package ks./bal. buc./pac.	pallet / pcs. pal./ks palet/buc.	kg / pcs. kg/ks. kg/buc.
		A	B	T			
NP15/40/120	NP15040120	40	120	1,5	50	5600	0,053
NP15/40/160	NP15040160	40	160	1,5	50	5600	0,072
NP15/50/200	NP15050200	50	200	1,5	50	5600	0,112
NP15/60/140	1552501	60	140	1,5	50	5600	0,094
NP15/60/160	1553001	60	160	1,5	50	5600	0,104
NP15/60/200	1553701	60	200	1,5	50	5600	0,135
NP15/60/240	NP15060240	60	240	1,5	50	4200	0,162
NP15/60/300	1554001	60	300	1,5	50	3600	0,200
NP15/60/340	1553601	60	340	1,5	50	3600	0,230
NP15/60/420	1553801	60	420	1,5	50	1300	0,280
NP15/60/500	1553901	60	500	1,5	50	2250	0,337
NP15/80/140	1554101	80	140	1,5	50	5600	0,130
NP15/80/200	NP15080200	80	200	1,5	50	4200	0,178
NP15/80/240	1554601	80	240	1,5	50	4200	0,220
NP15/80/280	1555001	80	280	1,5	50	3600	0,250
NP15/80/300	1555501	80	300	1,5	50	3600	0,264
NP15/80/340	1556001	80	340	1,5	50	2700	0,304
NP15/100/140	1557101	100	140	1,5	50	4800	0,160
NP15/100/200	NP15100200	100	200	1,5	50	2900	0,222
NP15/100/220	1557201	100	220	1,5	50	3600	0,240
NP15/100/240	1557301	100	240	1,5	50	3600	0,264
NP15/100/300	1557401	100	300	1,5	50	2700	0,330
NP15/100/340	1557601	100	340	1,5	50	2700	0,370
NP15/120/240	NP15120240	120	240	1,5	50	2900	0,320
NP15/120/260	1558201	120	260	1,5	50	2400	0,341
NP15/120/300	NP15120300	120	300	1,5	25	1500	0,380
NP15/140/200	1558501	140	200	1,5	50	3000	0,312
NP15/140/300	1559301	140	300	1,5	25	1500	0,460
NP15/160/260	1562001	160	260	1,5	25	2000	0,452
NP15/160/400	NP15160400	160	400	1,5	20	700	0,710
NP15/180/220	1563101	180	220	1,5	25	2000	0,440
NP20/40/120	2052501	40	120	2,0	50	5600	0,071
NP20/40/160	2053001	40	160	2,0	50	5600	0,094
NP20/50/200	2053501	50	200	2,0	50	5600	0,145
NP20/60/140	2054001	60	140	2,0	50	5600	0,123
NP20/60/200	2054501	60	200	2,0	50	5600	0,176
NP20/60/240	2055001	60	240	2,0	50	4200	0,215
NP20/80/200	2055501	80	200	2,0	50	4200	0,232
NP20/80/240	2056001	80	240	2,0	50	2800	0,292
NP20/80/300	2056501	80	300	2,0	50	2700	0,350
NP20/100/140	2057001	100	140	2,0	50	3800	0,204
NP20/100/200	2057501	100	200	2,0	50	2900	0,296
NP20/100/240	2058001	100	240	2,0	50	2900	0,348
NP20/100/260	2058501	100	260	2,0	50	1800	0,384
NP20/100/300	2059001	100	300	2,0	25	1800	0,450
NP20/100/400	2059201	100	400	2,0	25	650	0,596
NP20/100/500	2059401	100	500	2,0	25	1125	0,745
NP20/120/200	2059501	120	200	2,0	50	2900	0,348
NP20/120/240	2060001	120	240	2,0	50	1900	0,414
NP20/120/260	2060501	120	260	2,0	25	1500	0,476
NP20/120/300	2061001	120	300	2,0	25	1500	0,532
NP20/120/400	2061401	120	400	2,0	25	650	0,689
NP20/140/400	2061501	140	400	2,0	25	875	0,828
NP20/160/300	2061201	160	300	2,0	25	950	0,686
NP20/160/400	2061701	160	400	2,0	20	700	0,930
NP20/200/300	2062001	200	300	2,0	20	960	0,888
NP20/650/1200	NP20/650/1200	650	1200	2,0	1	70	12,250
NP25/650/1200	NP25/650/1200	650	1200	2,5	1	60	15,310
NP30/650/1500	NP30/650/1500	650	1500	3,0	1	40	23,000

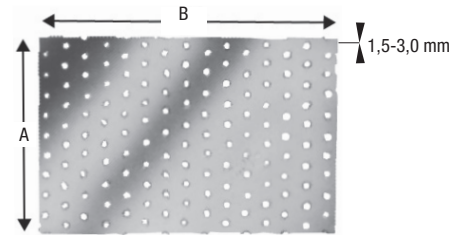

NP

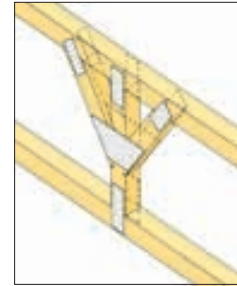

It. no. NEW č. p. NOVÉ nu. art. NOU	It. no. OLD č. p. STARÉ nu. art. VECHI	Dimensions/Rozměry/Dimensi- uni [mm]			pcs. / package ks./bal. buc./pac.	pallet / pcs. pal./ks palet/buc.	kg / pcs. kg/ks. kg/buc.
		A	B	T			
NP20/40/1200	2004001	40	1200	2,0	30	1200	0,703
NP20/60/1200-B	2006000	60	1200	2,0	20	800	1,050
NP20/80/1200-B	2008000	80	1200	2,0	15	600	1,387
NP20/100/1200-B	2010000	100	1200	2,0	10	400	1,710
NP20/120/1200-B	2012000	120	1200	2,0	10	400	2,070
NP20/140/1200-B	2014000	140	1200	2,0	10	400	2,388
NP20/160/1200-B	2016000	160	1200	2,0	5	200	2,772
NP20/180/1200-B	2018000	180	1200	2,0	5	200	3,108
NP20/200/1200-B	2020000	200	1200	2,0	5	200	3,461
NP20/220/1200-B	2022000	220	1200	2,0	5	200	3,802
NP20/240/1200-B	2024000	240	1200	2,0	5	200	4,147
NP20/260/1200-B	2026000	260	1200	2,0	5	200	4,493
NP20/280/1200-B	2028000	280	1200	2,0	5	200	4,838
NP20/300/1200-B	2030000	300	1200	2,0	5	200	5,184
NP25/40/1200-B	2504000	40	1200	2,5	20	800	0,877
NP25/60/1200-B	2506000	60	1200	2,5	15	600	1,320
NP25/80/1200-B	2508000	80	1200	2,5	10	400	1,785
NP25/100/1200-B	2510000	100	1200	2,5	10	400	2,185
NP25/120/1200-B	2512000	120	1200	2,5	10	400	2,610
NP25/140/1200-B	2514000	140	1200	2,5	5	200	3,092
NP25/160/1200-B	2516000	160	1200	2,5	5	200	3,384
NP25/180/1200-B	2518000	180	1200	2,5	5	200	3,972
NP25/200/1200-B	2520000	200	1200	2,5	5	200	4,308
NP25/220/1200-B	2522000	220	1200	2,5	1	200	4,735
NP25/240/1200-B	2524000	240	1200	2,5	1	200	5,264
NP25/260/1200-B	2526000	260	1200	2,5	1	200	5,594
NP25/280/1200-B	2528000	280	1200	2,5	1	200	6,024
NP25/300/1200-B	2530000	300	1200	2,5	1	200	6,454

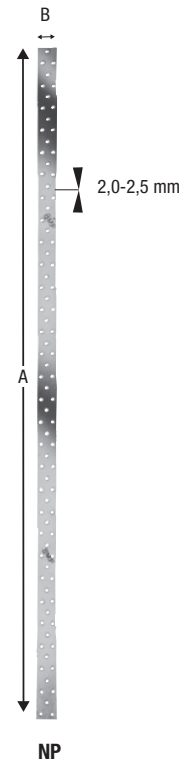

Flat nail plates/Ploché spojky/Conector plati

FLV

It. no. NEW č. p. NOVÉ nu. art. NOU	It. no. OLD č. p. STARÉ nu. art. VECHI	Dimensions/ Rozměry/Dimensiuni [mm]		pcs. / package ks./bal. buc./pac.	pallet / pcs. pal./ks palet/buc.	kg / pcs. kg/ks. kg/buc.
		A	B			
FLV40/100	FLV40/100	40	100	100	5800	0,080
FLV40/180	FLV40/180	40	180	100	4800	0,173
FLV55/135	FLV55/135	55	135	100	4800	0,119

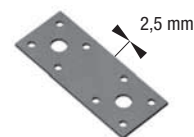

FLV40/100

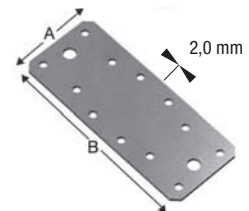

FLV55/135

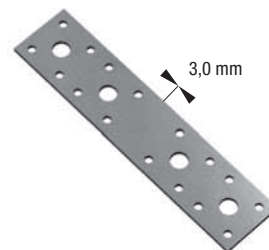

FLV40/180

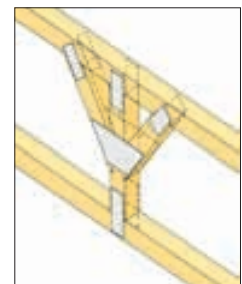

It. no. NEW č. p. NOVÉ nu. art. NOU	Dimensions/Rozměry/Dimensi- uni [mm]		pcs. / package ks./bal. buc./pac.	pallet / pcs. pal./ks palet/buc.	kg / pcs. kg/ks. kg/buc.
	A	B			
MP24	51	102	100	–	0,040
MP36	76	152	100	–	0,090

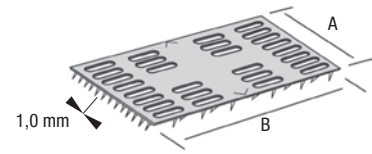

ETA 07/0317

It. no. NEW č. p. NOVÉ nu. art. NOU	It. no. OLD č. p. STARÉ nu. art. VECHI	Dimensions/Rozměry/Dimensi- uni [mm]					pcs. / package ks./bal. buc./pac.	pallet / pcs. pal./ks palet/buc.	kg / pcs. kg/ks. kg/buc.
		A	B	C	D	E			
SFN-B	1300100	177	139	53	53	39	25	1200	0,680
SFM-B	1300200	260	169	73	73	91	10	290	1,340
SFH-B	1300300	270	159	45	60	27	20	1680	0,507
SFHM-B	1300400	270	140	108	75	50	20	1260	0,620
SFHS-B	1300500	260	140	108	75	50	10	380	1,620
SHLM-B	1301400	360	280	53	–	–	1	200	2,830
SHLS-B	1301500	500	387	52	–	–	1	190	5,200

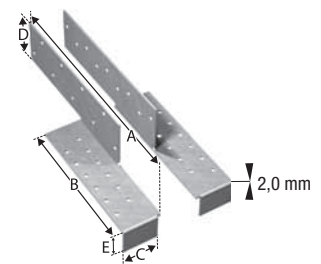

**SFH**

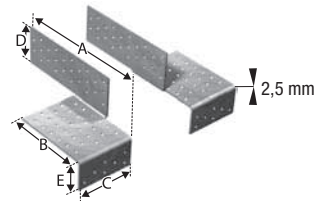

**SFM**

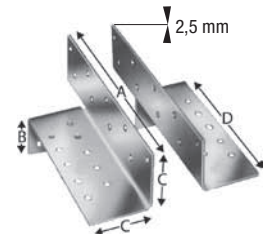

**SFN**

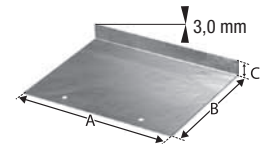

**SHLM**

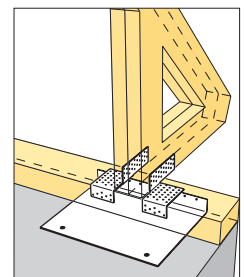
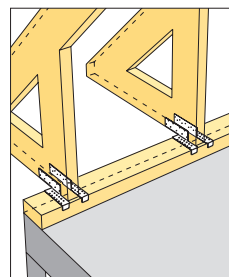
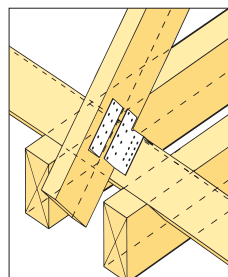



ETA 07/0317

It. no. NEW č. p. NOVÉ nu. art. NOU	It. no. OLD č. p. STARÉ nu. art. VECHI	Dimensions/Rozměry/Dimensi- uni [mm]				pcs. / package ks./bal. buc./pac.	pallet / pcs. pal./ks palet/buc.	kg / pcs. kg/ks. kg/buc.
		A	B	C	D			
SHB80G-B	2408000	84	170	220	140	15	480	1,232
SHB100G-B	2410000	104	170	240	140	15	360	1,432
SHB120G-B	2412000	124	170	260	140	10	320	1,635
SHH80G-B	2308000	84	300	140	-	15	480	1,240
SHH100G-B	2310000	104	280	140	-	10	320	1,360
SHH120G-B	2312000	124	260	140	-	10	320	1,545

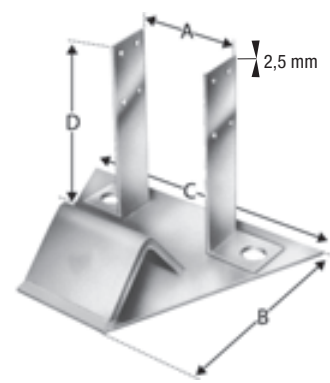

**SHB**

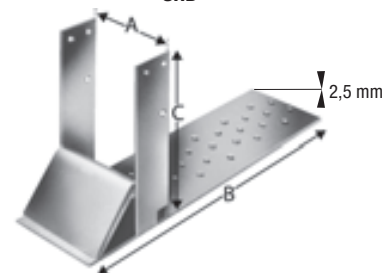

**SHH**

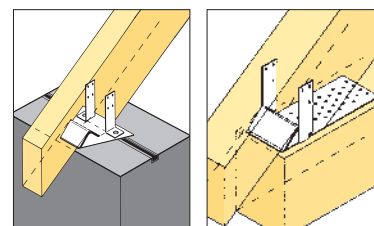

ETA 07/0053

It. no. NEW č. p. NOVÉ nu. art. NOU	It. no. OLD č. p. STARÉ nu. art. VECHI	Dimensions/Rozměry/Dimensi- uni [mm]			pcs. / package ks./bal. buc./pac.	pallet / pcs. pal./ks palet/buc.	kg / pcs. kg/ks. kg/buc.
		A	B	C			
GERB125-B	1112500	129	90	27	25	1000	0,496
GERB150-B	1115000	154	90	29	25	1000	0,588
GERB160-B	1116000	160	90	30	25	1000	0,616
GERB175-B	1117500	179	90	33	25	1000	0,674
GERB180-B	1118000	180	90	33	25	1000	0,676
GERB200DE-B	1120100	201	90	33	25	1000	0,736
GERB220-B	1122000	220	90	34	25	1000	0,800

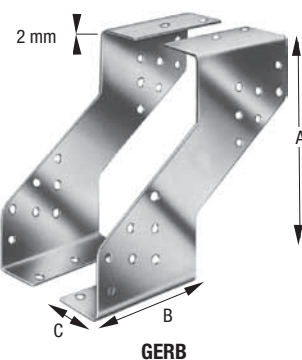

**GERB**

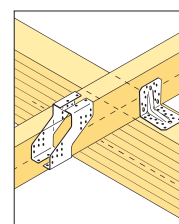



ETA 07/0053

It. no. NEW č. p. NOVÉ nu. art. NOU	It. no. OLD č. p. STARÉ nu. art. VECHI	Dimensions/Rozměry/Dimensi- uni [mm]			pcs. / package ks./bal. buc./pac.	pallet / pcs. pal./ks palet/buc.	kg / pcs. kg/ks. kg/buc.
		A	B	C			
GERG120/180-B	1221800	182	90	122	10	400	0,792
GERG120/200-B	1222000	202	90	122	10	320	0,850
GERG140/200-B	1242000	202	90	142	10	320	0,878
GERG120/220-B	1222200	222	90	122	10	320	0,907
GERG140/220-B	1242200	222	90	142	10	320	0,936
GERG160/220-B	1262200	222	90	162	10	320	0,965
GERG120/240-B	1222400	242	90	122	10	320	0,965
GERG140/240-B	1242400	242	90	142	10	320	0,994
GERG160/240-B	1262400	242	90	162	10	320	1,022
GERG120/260-B	1222600	262	90	122	10	320	1,022
GERG140/260-B	1242600	262	90	142	10	320	1,051
GERG160/260-B	1262600	262	90	162	*	*	1,080

- Price and delivery time on request / Cena a doba dodání na vyžádání / Timp de trep si de livrare la cerere

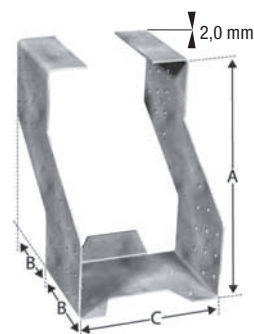
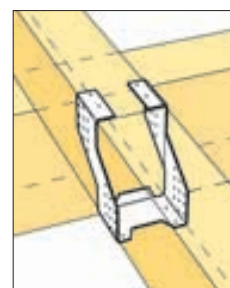
**GERG**

6

It. no. NEW č. p. NOVÉ nu. art. NOU	It. no. OLD č. p. STARÉ nu. art. VECHI	Dimensions/Rozměry/Dimensi- uni [mm]			pcs. / package ks./bal. buc./pac.	pallet / pcs. pal./ks palet/buc.	kg / pcs. kg/ks. kg/buc.
		A	B	C			
GERW90-B	2809000	90	140	20	25	1700	0,490
GERW120-B	2812000	120	180	20	25	1200	0,806
GERW140-B	2814000	140	180	20	20	960	0,922
GERW160-B	2816000	160	180	20	20	960	1,037
GERW180-B	2818000	180	180	20	15	720	1,152
GERW200-B	2820000	200	180	20	15	720	1,267
GERW220-B	2822000	220	180	20	15	720	1,310
GERW240-B	2824000	240	180	20	15	480	1,469
GERW260-B	2826000	260	180	20	10	570	1,568
GERW280-B <sup>1)</sup>	–	280	180	20	–	–	–
GERW300-B <sup>1)</sup>	–	300	180	20	–	–	–
GERW320-B <sup>1)</sup>	–	320	180	20	–	–	–
GERW340-B <sup>1)</sup>	–	340	180	20	–	–	–
GERW360-B <sup>1)</sup>	–	360	180	20	–	–	–

1) Currently without ETA-CE / Momentálně bez ETA-CE / In prezent nu ETA-CE

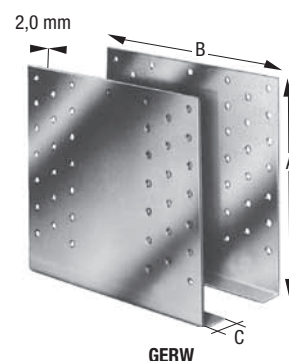
**GERW**



ETA 07/0285

It. no. NEW č. p. NOVÉ nu. art. NOU	It. no. OLD č. p. STARÉ nu. art. VECHI	Dimensions/Rozměry/Dimensiuni [mm]						pcs. / package ks./bal. buc./pac.	pallet / pcs. pal./ks palet/buc.	kg / pcs. kg/ks. kg/buc.
		A	B	C	D	E	F			
CMR	4415000	115-165	100	600	250	300	60	1	—	20,350

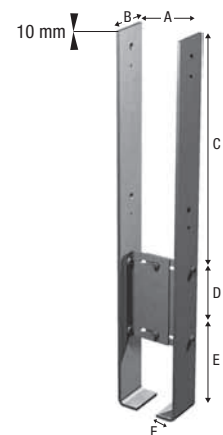

**CMR**

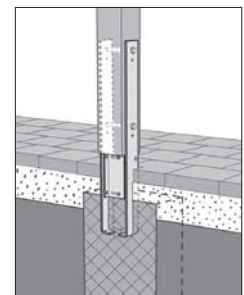

ETA 07/0285

It. no. NEW č. p. NOVÉ nu. art. NOU	It. no. OLD č. p. STARÉ nu. art. VECHI	Dimensions/Rozměry/Dimensiuni [mm]						pcs. / package ks./bal. buc./pac.	pallet / pcs. pal./ks palet/buc.	kg / pcs. kg/ks. kg/buc.
		A	B	C	D	E	F			
CPB40	CPB40	105	40	120	190-250	160	90	5	—	4,100
CPS40	CPS40	105	40	120	450	70	70	5	—	3,600
BH54	Blendhülse							5	—	0,660
BTBS40	Bohrschablone							1	—	1,100

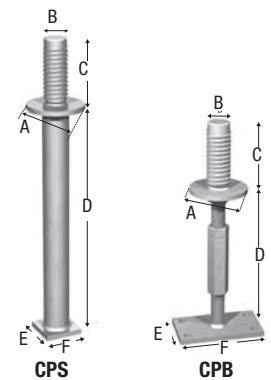

**CPS**

**CPB**



**BH54**

**BTBS40**

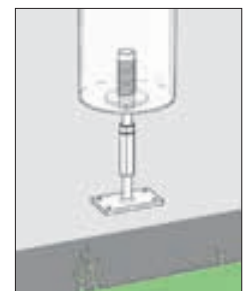



It. no. NEW č. p. NOVÉ nu. art. NOU	It. no. OLD č. p. STARÉ nu. art. VECHI	Dimensions/Rozměry/Dimensiuni [mm]					pcs. / package ks./bal. buc./pac.	pallet / pcs. pal./ks palet/buc.	kg / pcs. kg/ks. kg/buc.
		A	B	C	D	E			
PA70G	2607001	70	70	250	50	16	25	1000	0,598
PA90G	2609001	90	90	250	50	20	20	960	1,017

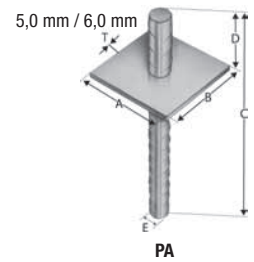

**PA**

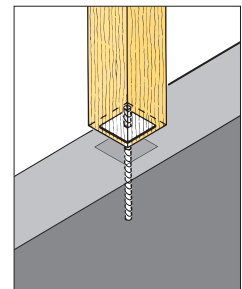

It. no. NEW č. p. NOVÉ nu. art. NOU	It. no. OLD č. p. STARÉ nu. art. VECHI	Dimensions/Rozměry/Dimensiuni [mm]					pcs. / package ks./bal. buc./pac.	pallet / pcs. pal./ks palet/buc.	kg / pcs. kg/ks. kg/buc.
		A	B	C	D	E			
PB40G	2609101	45	70	121	250	16	25	1000	0,666
PB70G	2609201	70	70	125	250	16	20	640	0,930
PBK60G	4210501	70	60	92	450	16	25	800	0,632
PBE60G-B	4200500	70	60	92	200	16	15	300	1,035

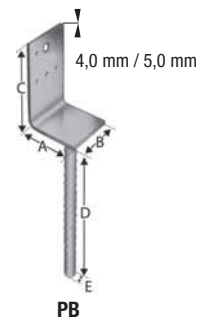

**PB**

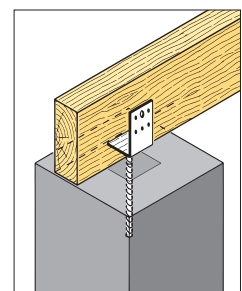

It. no. NEW č. p. NOVÉ nu. art. NOU	It. no. OLD č. p. STARÉ nu. art. VECHI	Dimensions/Rozměry/Dimensiuni [mm]					pcs. / package ks./bal. buc./pac.	pallet / pcs. pal./ks palet/buc.	kg / pcs. kg/ks. kg/buc.
		A	B	C	D	E			
PDKS48/40G	4124801	48	40	88,5	343-405	–	10	390	1,070
PDKS98/60G	4129801	98	60	88,5	343-405	–	10	200	1,310
PDKB48/40G	4134801	48	40	88,5	178-240	90	10	400	1,060
PDKB98/60G	4139801	98	60	88,5	178-240	90	10	400	1,300

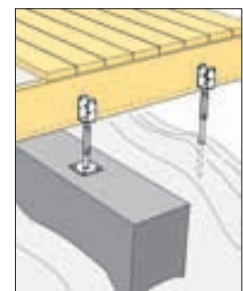
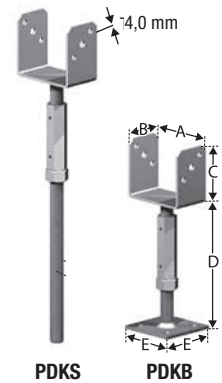

ETA 07/0285

It. no. NEW č. p. NOVÉ nu. art. NOU	Dimensions/Rozměry/Dimensiuni [mm]						pcs. / package ks./bal. buc./pac.	pallet / pcs. pal./ks palet/buc.	kg / pcs. kg/ks. kg/buc.
	A	B	C	D	E	F			
PGS24/130	80	24	125	130-195	180	100	6	–	2,650
PGS24/180	80	24	125	180-245	180	100	6	–	2,800
PGS24/230	80	24	125	230-295	180	100	6	–	3,070
PGS24/280	80	24	125	280-345	180	100	6	–	3,250

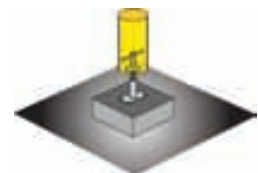
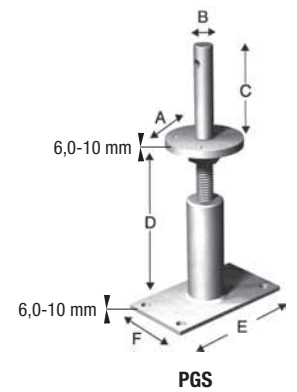

It. no. NEW č. p. NOVÉ nu. art. NOU	It. no. OLD č. p. STARÉ nu. art. VECHI	Dimensions/Rozměry/Dimensi- uni [mm]			pcs. / package ks./bal. buc./pac.	pallet / pcs. pal./ks palet/buc.	kg / pcs. kg/ks. kg/buc.
		A	B	C			
PH300G	1773001	300	30	25	25	1575	0,349
PH350G	1773501	350	30	25	25	1200	0,410
PH450G	1774501	450	40	31	25	1300	0,710



**PH**

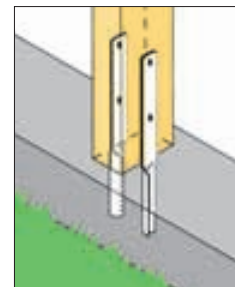

ETA 06/0270

It. no. NEW č. p. NOVÉ nu. art. NOU	It. no. OLD č. p. STARÉ nu. art. VECHI	Dimensions/Rozměry/Dimensiuni [mm]					pcs. / package ks./bal. buc./pac.	pallet / pcs. pal./ks palet/buc.	kg / pcs. kg/ks. kg/buc.
		A	B	C	D	E			
PIG-B	2600000	90	60	110	260	20	10	400	1,597
PILG	3100000	90	60	110	510	38	10	200	1,920

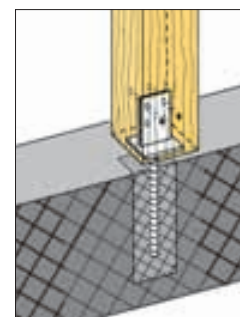
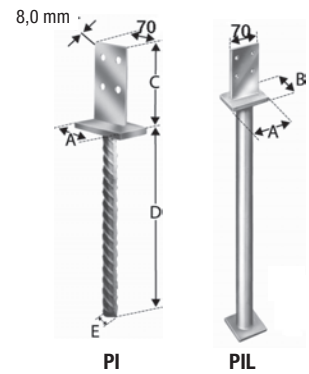



ETA 07/0285

It. no. NEW č. p. NOVÉ nu. art. NOU	It. no. OLD č. p. STARÉ nu. art. VECHI	Dimensions/Rozměry/Dimensiuni [mm]					pcs. / package ks./bal. buc./pac.	pallet / pcs. pal./ks palet/buc.	kg / pcs. kg/ks. kg/buc.
		A	B	C	D	E			
PIS70G-B	3196500	100	80	313	70	70	8	200	2,253
PISB160G-B	3196000	100	80	168	100	160	5	200	2,861
PISB260G-B	3197000	100	80	168	100	260	4	160	3,714
PISMAXIG-B	3197500	120	120	323	90	90	1	-	5,350
PISBMAXIG-B	3198000	120	120	148	200	200	1	-	8,080

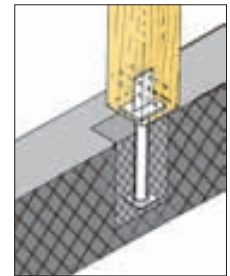
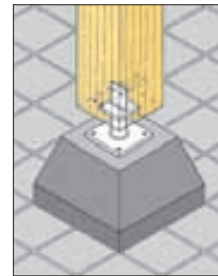
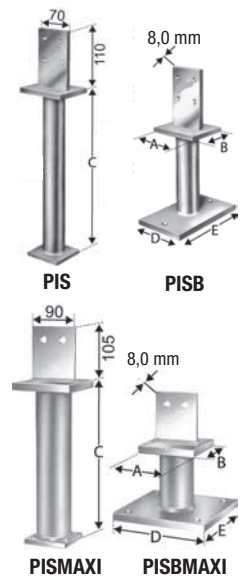

ETA 07/0285

It. no. NEW č. p. NOVÉ nu. art. NOU	It. no. OLD č. p. STARÉ nu. art. VECHI	Dimensions/Rozměry/Dimensiuni [mm]						pcs. / package ks./bal. buc./pac.	pallet / pcs. pal./ks palet/buc.	kg / pcs. kg/ks. kg/buc.
		A	B	C	D	E	F			
PJIBG	4300001	70	110	163-213	120	90	60	5	240	2,400
PJISG	4300101	70	110	355-405	-	90	60	4	240	1,900

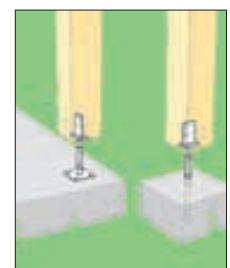
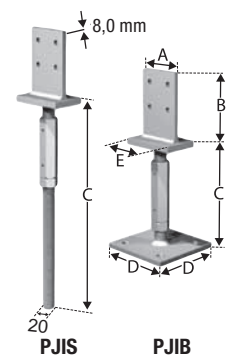



ETA 07/0285

It. no. NEW č. p. NOVÉ nu. art. NOU	It. no. OLD č. p. STARÉ nu. art. VECHI	Dimensions/Rozměry/Dimensiuni [mm]				pcs. / package ks./bal. buc./pac.	pallet / pcs. pal./ks palet/buc.	kg / pcs. kg/ks. kg/buc.
		A	B	C	D			
PJPSG	4301101	80	120	355-405	20	10	380	1,400
PJPBG	4301001	80	120	163-213	20	5	400	1,900

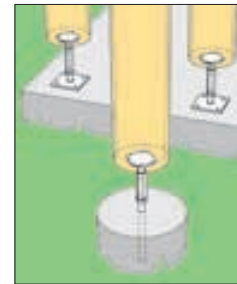
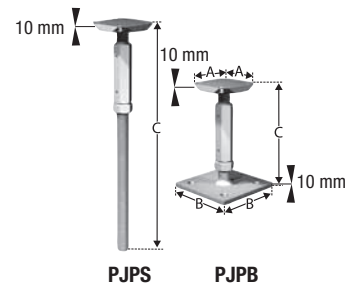

ETA 07/0285

It. no. NEW č. p. NOVÉ nu. art. NOU	It. no. OLD č. p. STARÉ nu. art. VECHI	Dimensions/Rozměry/Dimensiuni [mm]				pcs. / package ks./bal. buc./pac.	pallet / pcs. pal./ks palet/buc.	kg / pcs. kg/ks. kg/buc.
		A	B	C	D			
PL80/70G-B	3180700	80	70	126	500	10	200	1,940
PL100/70G-B	3110700	100	70	126	500	5	100	1,995
PL90/90G-B	3190900	90	90	141	500	5	100	2,333
PL100/90G-B	3110900	100	90	136	500	5	100	2,333
PL120/90G-B	3112000	120	90	126	500	5	100	2,333
PL140/90G-B	3114000	140	90	126	500	5	100	2,404

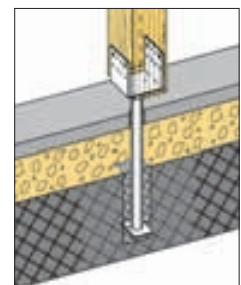



ETA 07/0285

It. no. NEW č. p. NOVÉ nu. art. NOU	It. no. OLD č. p. STARÉ nu. art. VECHI	Dimensions/Rozměry/Dimensiuni [mm]					pcs. / package ks./bal. buc./pac.	pallet / pcs. pal./ks palet/buc.	kg / pcs. kg/ks. kg/buc.
		A	B	C	D	E			
PLB60/65G-B	4040500	60	65	100	90	16	10	480	0,790
PLB60/165G-B	4041000	60	165	100	90	16	10	480	1,050
PLB80/90G-B	4042000	80	90	100	90	16	10	480	0,900
PLB80/190G-B	4043000	80	190	100	90	16	10	480	1,095
PLS60/65G-B	4030500	60	65	270	-	16	10	480	0,700
PLS60/165G-B	4031000	60	165	270	-	16	10	480	0,915
PLS80/90G-B	4032000	80	90	270	-	16	10	480	0,800
PLS80/190G-B	4033000	80	190	270	-	16	10	480	1,000

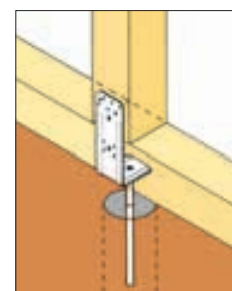
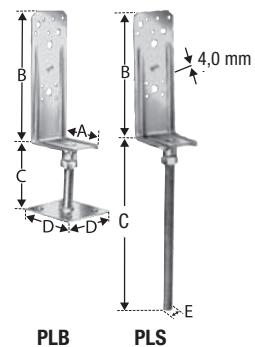

ETA 07/0285

It. no. NEW č. p. NOVÉ nu. art. NOU	It. no. OLD č. p. STARÉ nu. art. VECHI	Dimensions/Rozměry/Dimensiuni [mm]					pcs. / package ks./bal. buc./pac.	pallet / pcs. pal./ks palet/buc.	kg / pcs. kg/ks. kg/buc.
		A	B	C	D	E			
PPA100	4081001	100	100	100	130	130	10	480	1,100
PPA150	4081501	100	150	100	130	130	10	480	1,300
PPRC	4080001	100	100-150	100	130	130	10	-	1,500

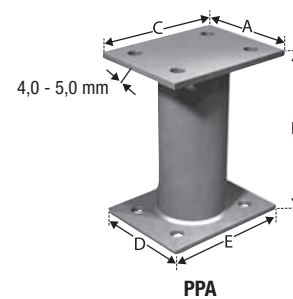



ETA 07/0285

It. no. NEW č. p. NOVÉ nu. art. NOU	It. no. OLD č. p. STARÉ nu. art. VECHI	Dimensions/Rozměry/Dimensiuni [mm]					pcs. / package ks./bal. buc./pac.	pallet / pcs. pal./ks palet/buc.	kg / pcs. kg/ks. kg/buc.
		A	B	C	D	E			
PPB70G	4060001	70	105	90	16	–	20	960	0,650
PPB75G	4060301	80	97	90	20	–	20	960	0,909
PPB80G-B	4060500	80	208	140	20	100	10	380	1,850
PPS80G-B	4061000	80	350	–	20	–	10	600	1,200

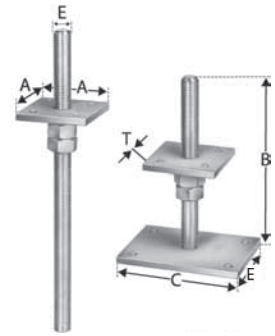
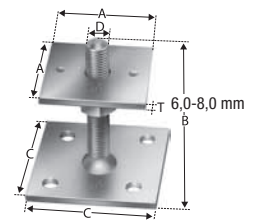

**PPS 80**

**PPB 80**

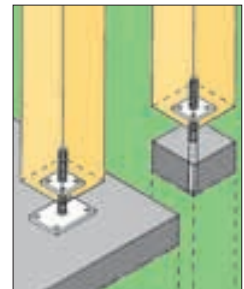



ETA 07/0285

It. no. NEW č. p. NOVÉ nu. art. NOU	It. no. OLD č. p. STARÉ nu. art. VECHI	Dimensions/Rozměry/Dimensiuni [mm]					pcs. / package ks./bal. buc./pac.	pallet / pcs. pal./ks palet/buc.	kg / pcs. kg/ks. kg/buc.
		A	B	C	D	E			
PPD48/40G	2648401	48	40	126	250	16	20	800	0,850
PPD50/40G	2650401	50	40	125	250	16	20	800	0,850
PPD73/40G	2673401	73	40	126	250	16	20	800	0,925
PPD100/40G	2610401	100	40	125	250	16	20	800	0,984
PPD98/60G	2698601	98	60	127	250	16	15	480	1,175
PPD73/70G	2673701	73	70	130	250	16	15	480	1,330
PPD75/70G	2675701	75	70	129	250	16	15	480	1,330
PPD80/70G-B	2680700	80	70	126	250	16	15	480	1,330
PPD100/70G	2610701	100	70	126	250	16	10	400	1,400
PPD90/90G	2690901	90	90	141	250	20	10	240	1,910
PPD100/90G	2610901	100	90	136	250	20	10	240	1,910
PPD115/90G	2611501	115	90	129	250	20	10	240	1,910
PPD120/90G	2612001	120	90	126	250	20	10	240	1,910
PPD123/90G	2612301	123	90	125	250	20	10	240	1,910
PPD125/90G-B	2612500	125	90	124	250	20	10	240	1,910
PPD140/90G	2614001	140	90	126	250	20	10	240	1,990
PPD148/90G	2614801	148	90	122	250	20	10	240	1,990

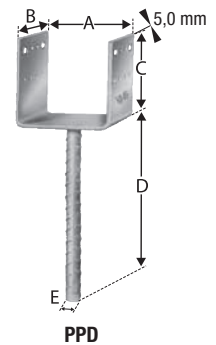

ETA 07/0285

It. no. NEW č. p. NOVÉ nu. art. NOU	It. no. OLD č. p. STARÉ nu. art. VECHI	Dimensions/Rozměry/Dimensiuni [mm]				pcs. / package ks./bal. buc./pac.	pallet / pcs. pal./ks palet/buc.	kg / pcs. kg/ks. kg/buc.
		A	B	C	D			
PP80G	4302001	80	260	-	20	15	600	1,100
PPL80G	4302101	80	510	70	38	10	200	1,550

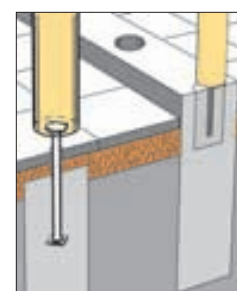
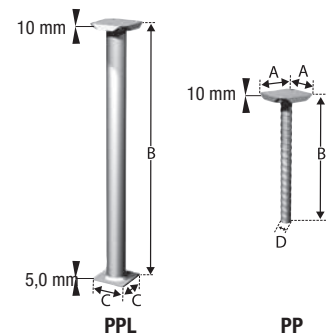



It. no. NEW č. p. NOVÉ nu. art. NOU	It. no. OLD č. p. STARÉ nu. art. VECHI	Dimensions/Rozměry/Dimensiuni [mm]					pcs. / package ks./bal. buc./pac.	pallet / pcs. pal./ks palet/buc.	kg / pcs. kg/ks. kg/buc.
		A	B	C	D	E			
PPU46/40G	4144601	46	40	94	200	16	20	800	0,630
PPU48/40G	4144801	48	40	93	200	16	20	800	0,628
PPU50/40G-B	4145000	50	40	92	200	16	20	800	0,630
PPU71/40G	4147101	71	40	94	200	16	20	800	0,662
PPU73/40G	4147301	73	40	93	200	16	20	800	0,662
PPU75/40G	4147501	75	40	92	200	16	20	800	0,662
PPU70/60G	4107001	70	60	97	200	16	20	640	0,848
PPU80/60G	4108001	80	60	92	200	16	20	640	0,848
PPU90/60G	4109001	90	60	97	200	16	20	640	0,891
PPU96/60G	4109601	96	60	94	200	16	20	640	0,891
PPU98/60G	4109801	98	60	93	200	16	20	480	0,891
PPU100/60G-B	4110000	100	60	92	200	16	20	640	0,891
PPU120/60G-B	4112000	120	60	102	200	16	20	640	1,021
PPU140/60G-B	4114000	140	60	92	200	16	20	640	1,021
PDL75/60G-B	4220500	75	60	94	450	16	15	300	1,222
PDL100/60G-B	4221000	100	60	96	450	16	15	300	1,259

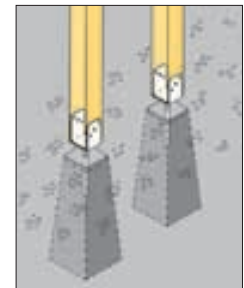
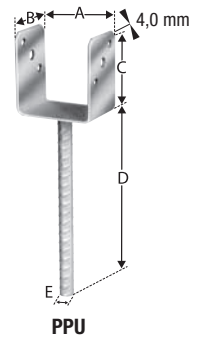

It. no. NEW č. p. NOVÉ nu. art. NOU	It. no. OLD č. p. STARÉ nu. art. VECHI	Dimensions/Rozměry/Dimensiuni [mm]					pcs. / package ks./bal. buc./pac.	pallet / pcs. pal./ks palet/buc.	kg / pcs. kg/ks. kg/buc.
		A	B	C	D	E			
PTB48G	4070001	48	60	106	39	100	10	380	1,020

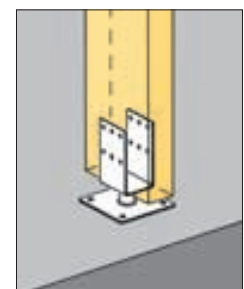
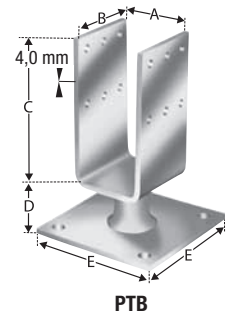

It. no. NEW č. p. NOVÉ nu. art. NOU	It. no. OLD č. p. STARÉ nu. art. VECHI	Dimensions/Rozměry/Dimensiuni [mm]				pcs. / package ks./bal. buc./pac.	pallet / pcs. pal./ks palet/buc.	kg / pcs. kg/ks. kg/buc.
		A	B	C	D			
PU70-B	4000500	71	70	107	131	20	760	0,690
PU80-B	4003000	81	70	102	126	20	760	0,690
PU90-B	4004000	91	70	107	131	20	760	0,730
PU100-B	4005000	101	70	102	126	20	760	0,730
PU120-B	4006000	121	70	92	116	20	760	0,730
PU140-B	4007000	141	70	82	106	20	760	0,730

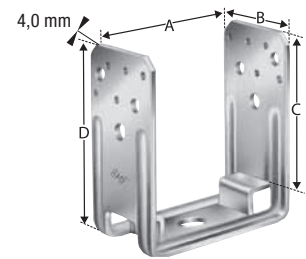

**PU**

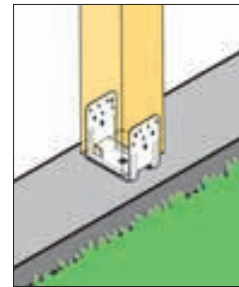

ETA 07/0285

It. no. NEW č. p. NOVÉ nu. art. NOU	It. no. OLD č. p. STARÉ nu. art. VECHI	Dimensions/Rozměry/Dimensiuni [mm]			pcs. / package ks./bal. buc./pac.	pallet / pcs. pal./ks palet/buc.	kg / pcs. kg/ks. kg/buc.
		A	B	C			
PUA45-B	2904500	46	127	70	25	950	0,504
PUA50-B	2905000	51	125	70	25	950	0,504
PUA60-B	2906000	61	120	70	25	950	0,504
PUA70-B	2907000	71	115	70	25	950	0,504
PUA80-B	2908000	81	110	70	25	950	0,504
PUA90-B	2909000	91	115	70	25	950	0,538
PUA100-B	2910000	101	110	70	25	950	0,538
PUA120-B	2912000	121	110	70	25	950	0,571
PUA/B42-B	2990000	42	27	70	25	1875	0,141
PUA/B47-B	2990500	47	25	70	25	1875	0,141
PUA/B57-B	2991000	57	20	70	25	1875	0,141
PUA/B67-B	2991500	67	25	70	25	1875	0,175
PUA/B77-B	2995000	77	20	70	25	1875	0,175
PUA/B87-B	2996000	87	25	70	25	1875	0,208
PUA/B97-B	2997000	97	20	70	25	1875	0,208
PUA/B117-B	2999000	117	20	70	25	1875	0,242

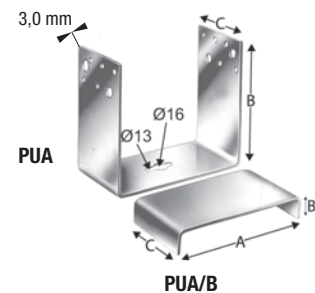

**PUA**

**PUA/B**

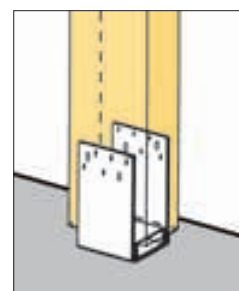



ETA 07/0285

It. no. NEW č. p. NOVÉ nu. art. NOU	It. no. OLD č. p. STARÉ nu. art. VECHI	Dimensions/Rozměry/Dimensiuni [mm]					pcs. / package ks./bal. buc./pac.	pallet / pcs. pal./ks palet/buc.	kg / pcs. kg/ks. kg/buc.
		A	B	C	D	E			
PVD80G-B	3195000	80-120	120	70	248-298	160	10	400	2,052
PVD120G-B	3194800	120-160	120	70	248-298	160	10	240	2,165
PVDB80G-B	3195100	80-120	120	70	136-186	160	8	192	2,510
PVDB120G-B	3194900	120-160	120	70	136-186	160	5	200	2,620
PVIG-B	3195200	90	110	60	232-282	-	10	400	1,329
PVIBG-B	3195300	90	110	60	120-170	-	10	400	1,787

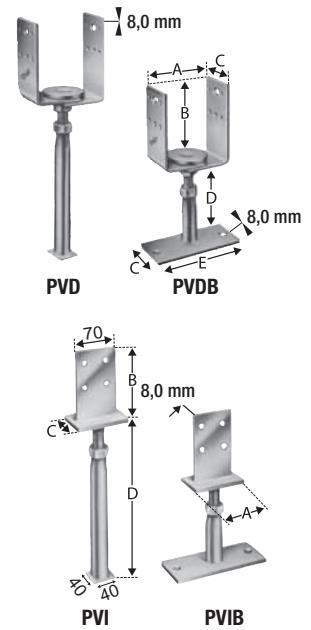

It. no. NEW č. p. NOVÉ nu. art. NOU	Dimensions/Rozměry/Dimensiuni [mm]						pcs. / package ks./bal. buc./pac.	pallet / pcs. pal./ks palet/buc.	kg / pcs. kg/ks. kg/buc.
	A	B	C	D	E	F			
JDB18G	68	24	125	185-235	160	90	10	-	2,110
JGB18G	56	16	125	185-235	160	90	5	240	1,700
JGS30G	56	16	126	385-425	-	-	10	-	1,650
PDB17G	68	24	125	170	160	90	10	-	1,720
PDB27G	68	24	125	270	160	90	10	-	1,970
PDS50G	80	24	125	500	70	70	8	160	1,930

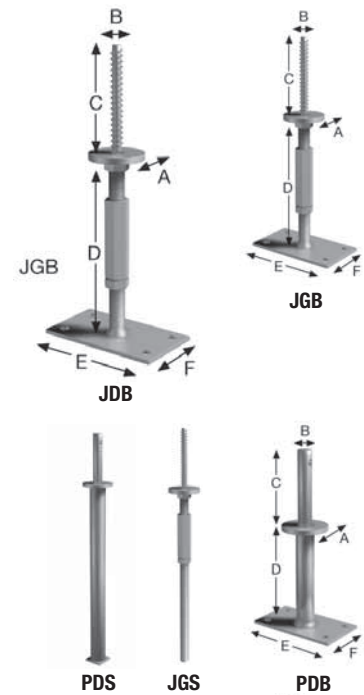

JDB



JGS

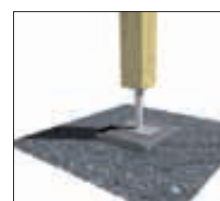

PDB



PDS



ETA 07/0314

It. no. NEW č. p. NOVÉ nu. art. NOU	It. no. OLD č. p. STARÉ nu. art. VECHI	Dimensions/Rozměry/Dimensiuni [mm]					pcs. / package ks./bal. buc./pac.	pallet / pcs. pal./ks palet/buc.	kg / pcs. kg/ks. kg/buc.
		A	A*	B	C	D			
HE175	1600101	175	up to/do/pentru 315	40	30	15	100	4800	0,184
HE135-B	1600200	135		40	30	15	100	6400	0,150
PROFA108-B	1610000	108		35	22,5	8	100	5800	0,078
PROFA158-B	1612000	158		35	22,5	8	100	6400	0,117
PROFA198-B	1614000	198		35	22,5	8	100	6400	0,148
PROFA159-B	1620000	159	up to/do/pentru 359	35	30	9	100	4800	0,160

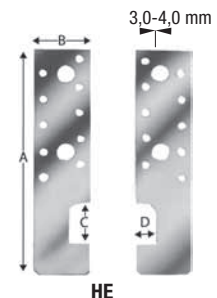

Build to order in 20 mm/Možnost výroby na zakázku ve 20 mm/Obicej 20 mm

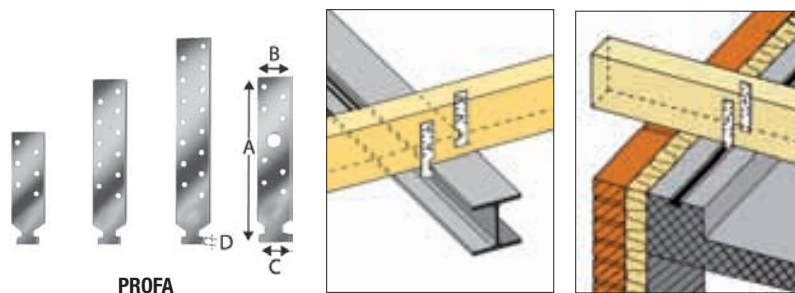

Connecting wallstrip/Připojovací pás do zdi/Benzi perete conectoare

**C2KS**

It. no. č. p. nu. art.	pcs. / package ks./bal. buc./pac.	pallet / pcs. pal./ks palet/buc.	kg / pcs. kg/ks. kg/buc.
Stainless steel / Ušlechtilá ocel / Oțel inoxidabil			
C2KS	10 set/sada/rata	700	0,800

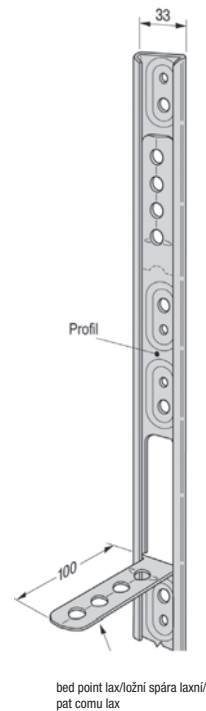
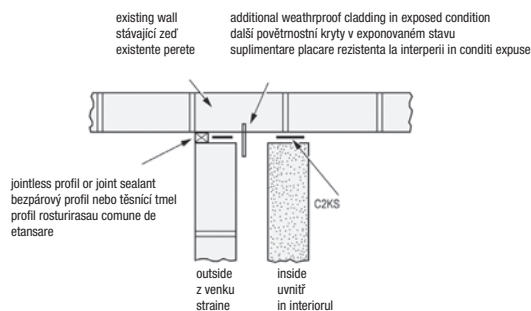
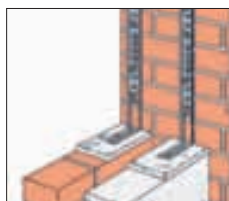

It. no. č. p. nu. art.	Dimensions/Rozměry/Dimensiuni [mm]			pcs. / package ks./bal. buc./pac.	pallet / pcs. pal./ks palet/buc.	kg / pcs. kg/ks. kg/buc.
	A	B	C			
DBT1Z-R50	41	34	30	50	540	0,680
N3,75x30/1kg	Galvanized nail / Pozinkovaný hřebík / Galvanizad unghii 3,75x30 mm			10	–	1,000

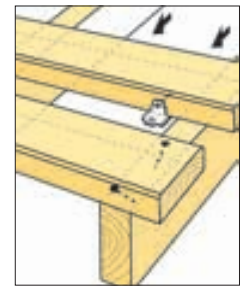
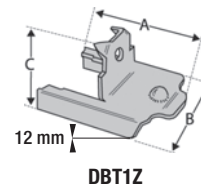

It. no. č. p. nu. art.	Dimensions/Rozměry/Dimensi- uni [mm]			pcs. / package ks./bal. buc./pac.	pallet / pcs. pal./ks palet/buc.	kg / pcs. kg/ks. kg/buc.
	A	B	C			
DBCS	30	39	11	100	19800	0,022

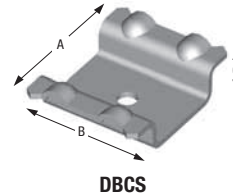

It. no. č. p. nu. art.	pcs. / package ks./bal. buc./pac.	pallet / pcs. pal./ks palet/buc.	kg / pcs. kg/ks. kg/buc.
HDMS-2	100	144	2,950
HDMS-7	100	144	3,150
HDMS-A60	20	640	0,650



It. no./č. p./ nu. art.	Content/Obsah/Continut
HDMS-2	80 St. Terrace connectors/Terasová spojka/Conectori terase
	20 St. Connector for fitting of the edge/Spojka pro montáž hrany/Conectori montarea de la marginea
	240 St. Screw for ground timber/Šroub pro dřevěnou podlahu/Surub pentru podea din lemn 4,5x18 mm
	75 St. Screw for wooden beams/Šroub pro dřevěné nosníky/Surub pentrugrinu de lemn 4,5x40 mm
	2 St. Bits Torx T20 L = 70 mm
HDMS-7	100 St. Terrace connectors/Terasová spojka/Conectori terase
	240 St. Screw for ground timber/Šroub pro dřevěnou podlahu/Surub pentru podea din lemn 4,5x18 mm
	120 St. Screw for wooden beams/Šroub pro dřevěné nosníky/Surub pentrugrinu de lemn 4,5x40 mm
	2 St. Bits Torx T20 L = 70 mm
HDMS-A60	10 St. Angle bracket/Úhelník/Coltar de imbinare
	50 St. Screw for ground timber/Šroub pro dřevěnou podlahu/Surub pentru podea din lemn 4,5x18 mm
	25 St. Screw for wooden beams/Šroub pro dřevěné nosníky/Surub pentrugrinu de lemn 4,5x40 mm

Terrace clips from Simpson Strong-Tie are price friendly solution for montage of terrace and balcony floor. Terrace connector EB-TY is made from plastic which is very resistant against outdoor conditions. It comes together with screws which are made from stainless steel.

Terasové spoje Simpson Strong-Tie jsou cenově výhodným řešením pro montáž terasových a balkonových podlah. Terasové spojky EB-TY se skládají z plastového dílu, který je odolný venkovním podmínkám a je dodáván společně s příslušnými šrouby z ušlechtilé oceli.

Clipuri de Terasa de la Simpson Strong-Tie sunt solutia de pret prietenos pentru montaj la terace și podele de balcon. Conectorii de terasa EB-TY sunt fabricati din plastic, foarte rezistent la condițiile din aer liber. Vin împreună cu șuruburi, fabricate din oțel inoxidabil.

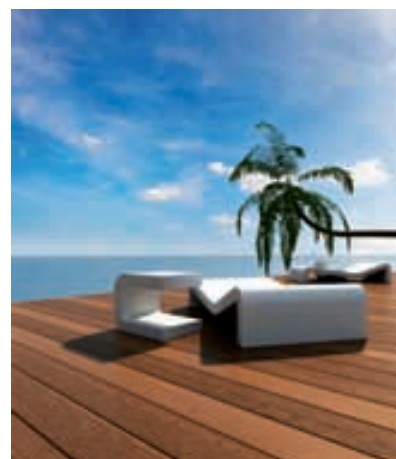

## 175-EBTYW

### Applications:

13 mm and 25 mm wide timber  
Suitable for pine wood and cedar

### Dimension:

High: 13mm; Wide: 25 mm  
Long: 59 mm; Strong: 4 mm  
Path-strong: 2,5 mm

### Požiti:

13 mm a 25 mm široké dřevo.  
Vhodné pro borové a cedrové dřevo

### Rozměry:

Výška: 13mm; Šířka: 25 mm  
Délka: 59 mm; Tloušťka: 4 mm  
Tloušťka můstku: 2,5 mm

### Plicatii pentru lemn:

13 mm și 25 mm lățime. Potrivit pentru lemn de pin și cedru

### Dimensiuni:

Înălț: 13mm; Lat: 25 mm  
Lung: 59 mm; Rezistent: 4 mm  
Tag-rezistent: 2,5 mm



## 175-EBTYLC

### Applications:

Suitable for artificially dried wood, jointed wood and natural wood

### Dimension:

High: 13mm; Wide: 25 mm  
Long: 60 mm; Strong: 4 mm  
Path-strong: 6 mm

### Požiti:

Vhodné pro uměle vysušené dřevo, lepené dřevo a syrové přírodní dřevo

### Rozměry:

Výška: 13mm; Šířka: 25 mm  
Délka: 60 mm; Tloušťka: 4 mm  
Tloušťka můstku: 6 mm

### Plicatii pentru lemn:

Potrivit pentru lemn uscat artificial, lemn stratificat și lemn natural

### Dimensiuni:

Înălț: 13mm; Lat: 25 mm  
Lung: 60 mm; Rezistent: 4 mm  
Tag-rezistent: 6 mm



## 175-EBTYBG

### Applications:

Suitable for stronger plant flooring, which are most often placed on sands malls

### Dimension:

High: 16 mm; Wide: 33 mm  
Long: 66 mm; Strong: 4 mm  
Path-strong: 6 mm

### Požiti:

Vhodné pro silnější prkenné podlahy, které jsou často umístěny na plážových promenádách a chodnících

### Rozměry:

Výška: 16 mm; Šířka: 33 mm  
Délka: 66 mm; Tloušťka: 4 mm  
Tloušťka můstku: 6 mm

### Plicatii pentru lemn:

Potrivit pentru podele de baza asezate pe nisip

### Dimensiuni:

Înălț: 16 mm; Lat: 33 mm  
Lung: 66 mm; Rezistent: 4 mm  
Tag-rezistent: 6 mm



**Material/Materiál/Material:** plastic, black / plast černý / plastic, negru

**Type of joint/Typ spoje/ Tip dezasamblare:** floor joint / podlahový / podea

**Attachment/Upevnění/Atașament:** by screwing SK screws from stainless steel 4,5 mm x 55 mm/ sešroubováním pomocí SK šroubů z ušlechtilé oceli průměr 4,5 mm x 55 mm/ prin fixarea cu șuruburi - SK din oțel inoxidabil 4,5 mm x 55 mm

**Benefits/Přednosti/Beneficii:** accurate and fast assembly/přesná a rychlá montáž/asamblare corecta și rapida

**Use for/Použití/Utilizarea:** main use for terrace and balcony floors, shutters etc. /pro terasové a balkonové podlahy, bednění a další/efectivă pentru pardoseli de terasă și balcon, obloane etc

lt. no. NEW č. p. NOVÉ nu. art. NOU	lt. no. OLD č. p. STARÉ nu. art. VECHI	pcs. / package ks./bal. buc./pac.	pallet / pcs. pal./ks palet/buc.	kg / pcs. kg/ks. kg/buc.
ABR9020S-B	ABR9020S	*	*	*
ABR9015S-B	ABR9015S	*	*	*
ABR90S-B	07090 80	50	5000	0,200
AB90S-B	07091 80	100	5000	0,200
ABR105S-B	07105 80	50	2550	0,382
AB105S-B	07106 80	50	2550	0,382
ABR70S-B	07070 80	100	6500	0,108
AB70S-B	07071 80	100	6600	0,108
AC35350S	AC35350S	100	10200	0,048
ABB40390S-B	07390 80	100	5700	0,161
AC55365S-B	07365 80	100	6000	0,150
ANP256660S-B	08666 80	100	7200	0,136
(60x100)	0311280	1	-	0,270
(80x120)	0322180	50	1600	0,380
(100x140)	0331880	1	-	0,433
(120x160)	0342180	1	-	0,580
(140x180)	0352180	1	-	0,650
SPF170LS-B	02170 80	100	9600	0,096
SPF170RS-B	02171 80	100	9600	0,096
SPF210LS-B	02210 80	100	7200	0,134
SPF210RS-B	02211 80	100	7200	0,134
BAN204025S	27419 80	1	30	15,000
BAN102010S	27110 80	10	450	1,525



lt. no. NEW č. p. NOVÉ nu. art. NOU	lt. no. OLD č. p. STARÉ nu. art. VECHI	pallet / package pal./bal. palet/pac.	pcs. / package ks./bal. buc./pac.	kg / package kg/bal. kg/pac.
CNA4,0X40S	99440 80	480	250	1,073
CNA4,0X50S	99450 80	480	250	1,400
CNA4,0X60S	99460 80	480	250	1,708
CNA6,0X60S	99660 80	320	100	1,525
CSA5,0X25S	95525 80	480	250	0,628
CSA5,0X35S	95535 80	480	250	0,935
CSA5,0X40S	95540 80	480	250	0,975





ETA 07/0314

It. no. NEW č. p. NOVÉ nu. art. NOU	It. no. OLD č. p. STARÉ nu. art. VECHI	Dimensions/Rozměry/Dimensiuni [mm]			pcs. / package ks./bal. buc./pac.	pallet / pcs. pal./ks palet/buc.	kg / pcs. kg/ks. kg/buc.
		A	B	C			
BETA2/200-B	1720000	40	180	20	150	7200	0,118
BETA2/300-B	1730000	40	280	20	100	4200	0,176
BETA2/400-B	1740000	40	380	20	80	4160	0,230
BETA2/500-B	1750000	40	480	20	50	2700	0,296
BETA2/600-B	1760000	40	580	20	50	2700	0,350
BETA4/200-B	1720400	40	180	20	75	3600	0,251
BETA4/300-B	1730400	40	280	20	50	2100	0,376
BETA4/400-B	1740400	40	380	20	40	1560	0,500
BETA4/500-B	1750400	40	480	20	25	1350	0,632
BETA4/600-B	1760400	40	580	20	25	1350	0,760

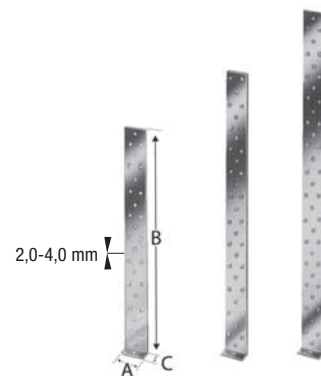

BETA

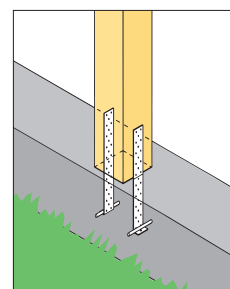

ETA 07/0314

It. no. NEW č. p. NOVÉ nu. art. NOU	It. no. OLD č. p. STARÉ nu. art. VECHI	Dimensions/Rozměry/Dimensiuni [mm]				pcs. / package ks./bal. buc./pac.	pallet / pcs. pal./ks palet/buc.	kg / pcs. kg/ks. kg/buc.
		A	B	C	D			
HD340M12G-B	1040500	340	182	40	15	10	380	1,279
HD400M16G-B	1041000	400	123	40	15	10	650	1,228
HD420M16G-B	1041500	420	222	60	20	8	224	2,435
HD420M20G-B	1042000	420	102	60	20	10	650	1,221
HD480M20G-B	1042500	480	123	60	20	10	420	1,844

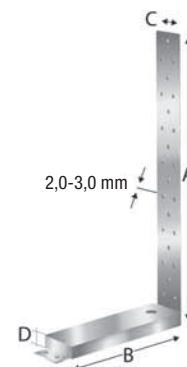

HD

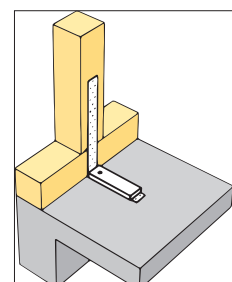





ETA 07/0314

It. no. č. p. nu. art.	Dimensions/Rozměry/Dimensi- uni [mm]			pcs. / package ks./bal. buc./pac.	pallet / pcs. pal./ks palet/buc.	kg / pcs. kg/ks. kg/buc.
	A	B	C			
LTT20B	502	70	51	10	500	0,750
HTT5 (replace/nahrazuje/ inlocuii HTT16)	406	61	64	10	400	0,951
HTT22	559	61	70	10	300	1,200

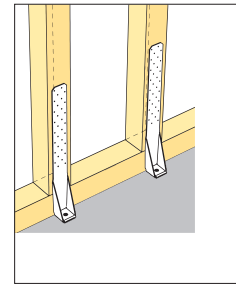
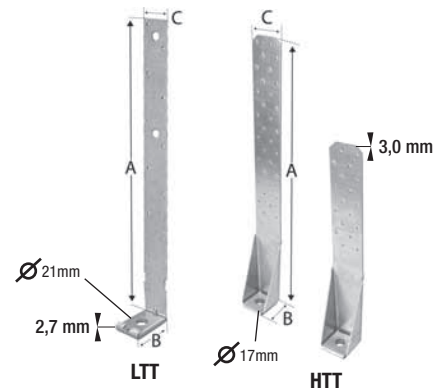

ETA 07/0314

It. no. NEW č. p. NOVÉ nu. art. NOU	It. no. OLD č. p. STARÉ nu. art. VECHI	Dimensions/Rozměry/Dimensiuni [mm]			pcs. / package ks./bal. buc./pac.	pallet / pcs. pal./ks palet/buc.	kg / pcs. kg/ks. kg/buc.
		A	B	C			
HD2P60G-B	1043000	400	220	60	10	350	1,500
HD2P40G	HD2P40G	250	163	40	10	400	0,850
HD2PL40G	HD2PL40G	250	379	40	5	200	1,800
HD2PSG	HD2PSG	336	163	60	10	400	1,500
HD2PLSG	HD2PLSG	336	379	60	5	160	2,500
HD2P1L-B		380	220	55			
HD2P1R-B		380	220	55			
HD2P2L-B		380	163	55			
HD2P2R-B		380	163	55			
US40/50/10G-B	0700200	40	50	-	50	4950	0,157
US50/50/8G-B	0700300	50	50	-	50	4950	0,157
JT2-3-5,5x25	9502200	E-JOT screw/šroub/surub JT2-3/5,5x25			100	-	0,618

Upper part for/  
Horní část pro/  
Parte superioara pentru

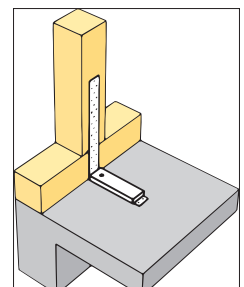
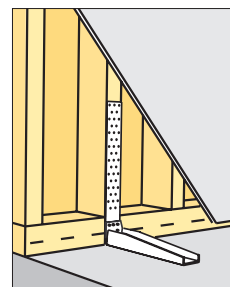
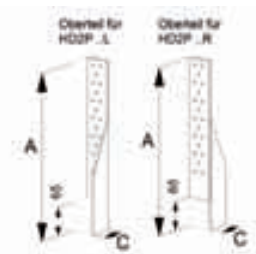
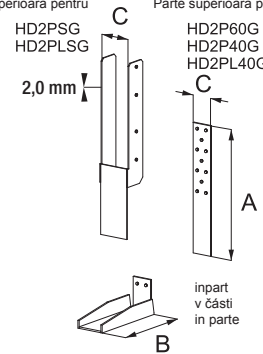



ETA 07/0314

It. no. NEW č. p. NOVÉ nu. art. NOU	It. no. OLD č. p. STARÉ nu. art. VECHI	Dimensions/Rozměry/Dimensiuni [mm]				pcs. / package ks./bal. buc./pac.	pallet / pcs. pal./ks palet/buc.	kg / pcs. kg/ks. kg/buc.
		A	B	C	T			
AH9035	0703501	90	35	40	2,5	100	6400	0,100
AH16050	0705001	160	50	40	3,0	100	4800	0,184
AH19050/2	0705101	192	52	40	2,0	100	5400	0,151
AH29050/2	0705201	292	52	40	2,0	50	4200	0,212
AH39050/2	AH39050/2	390	52	40	2,0	25	1950	0,280
AH49050/2	AH49050/2	492	52	40	2,0	25	1050	0,340
AH61050/2	AH61050/2	612	52	40	2,0	25	625	0,420
AH19050/4	AH19050/4	194	54	40	4,0	50	2700	0,300
AH29050/4	AH29050/4	294	54	40	4,0	25	1800	0,420
AH39050/4	AH39050/4	394	54	40	4,0	25	900	0,550
AH49050/4	AH49050/4	494	54	40	4,0	25	1050	0,680
AH61050/4	AH61050/4	614	54	40	4,0	25	500	0,830
US40/50/10G-B	0700200	40	50	-	10,0	50	4950	0,157

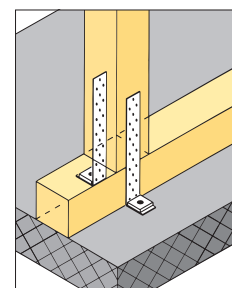

AH

AH9035  
AH16050

It. no. NEW č. p. NOVÉ nu. art. NOU	It. no. OLD č. p. STARÉ nu. art. VECHI	Dimensions/Rozměry/Dimensiuni [mm]				pcs. / package ks./bal. buc./pac.	pallet / pcs. pal./ks palet/buc.	kg / pcs. kg/ks. kg/buc.
		A	B	C	T			
RFC80/120	RFC80/120	185	70	32	2,0	30	1200	0,240
EBR60-B	0799500	80	80	57	1,5	100	5400	0,105
EBR80-B	0799600	123	123	74	1,5	100	4800	0,206
TA9Z	TA9Z	210	41	–	2,5	50	2400	0,290
TA10Z	TA10Z	260	41	–	2,5	50	2400	0,340
FLVW40/100	FLVW40/100	53	53	40	2,5	100	6400	0,080
FLVW40/180	FLVW40/180	93	93	40	3,0	100	5800	0,173
FLVW40/100-135	FLVW40/100-135	50	50	40	2,5	100	4800	0,080
FLVW40/180-135	FLVW40/180-135	90	90	40	3,0	100	4800	0,173
FLVW55/135-135	FLVW55/135-135	70	70	55	2,0	100	4800	0,119
66L	66L	38	150	150	2,0	25	5000	0,180
66T	66T	38	125	150	2,0	25	5000	0,180

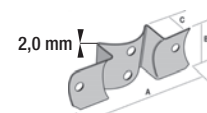

RFC

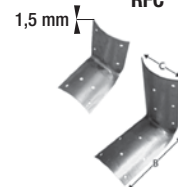

EBR

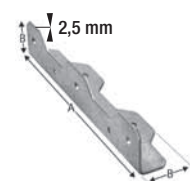

TAZ

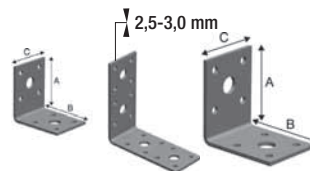

FLVW

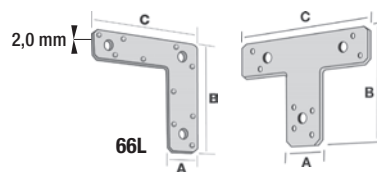

66L

66T

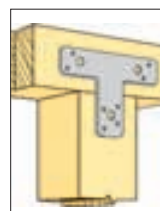
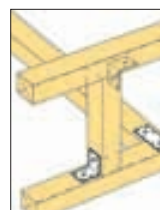
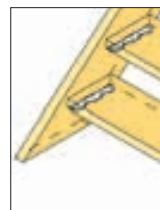
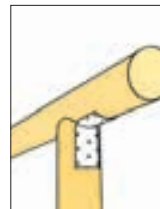

It. no. NEW č. p. NOVÉ nu. art. NOU	It. no. OLD č. p. STARÉ nu. art. VECHI	Dimensions/Rozměry/Dimensiuni [mm]				pcs. / package ks./bal. buc./pac.	pallet / pcs. pal./ks palet/buc.	kg / pcs. kg/ks. kg/buc.
		A	B	C	T			
CRE50	CRE50	18	50	50	4,0	150	9000	0,050
CRE70	CRE70	18	70	70	4,0	150	9000	0,070
CRE100	CRE100	18	100	100	4,0	100	6000	0,110
CRE120	CRE120	18	120	120	4,0	50	3000	0,130
CRE140	CRE140	18	140	140	4,0	50	3000	0,150
CRE160	CRE160	20	160	160	4,0	50	3000	0,200
CRE190	CRE190	20	190	190	4,0	50	1500	0,230
CRE250	CRE250	20	250	250	4,0	50	1500	0,310
EC30/2	EC30/2	15	30	30	2,0	500	30000	0,013
EC40/2	EC40/2	15	40	40	2,0	500	30000	0,017
EC50/2	EC50/2	15	50	50	2,0	500	30000	0,021
EC60/2	EC60/2	15	60	60	2,0	500	30000	0,027
EC70/2,5	EC70/2,5	15	70	70	2,5	200	12000	0,039
EC80/2,5	EC80/2,5	15	80	80	2,5	200	12000	0,045
EC90/3	EC90/3	18	90	90	3,0	200	12000	0,073
EC100/3	EC100/3	18	100	100	3,0	200	12000	0,075
EC120/3	EC120/3	18	120	120	3,0	200	6000	0,098
EC140/3	EC140/3	18	140	140	3,0	200	6000	0,115
EFIXR553	EFIXR553	50	55	30	2,0	150	9000	0,040

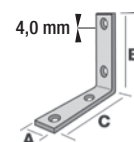

CRE

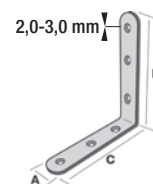

EC

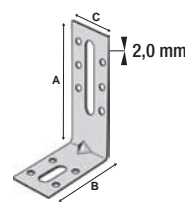

EFIXR553



lč. no. NEW č. p. NOVÉ nu. art. NOU	lč. no. OLD č. p. STARÉ nu. art. VECHI	Dimensions/Rozměry/Dimensiuni [mm]					pcs. / package ks./bal. buc./pac.	pallet / pcs. pal./ks palet/buc.	kg / pcs. kg/ks. kg/buc.
		A	B	C	D	T			
PPU46/40	4144601	46	40	94	200	4,0	20	800	0,630
PPU48/40	4144801	48	40	93	200	4,0	20	800	0,628
PPU50/40	4145001	50	40	92	200	4,0	20	800	0,630
PPU71/40	4147101	71	40	94	200	4,0	20	800	0,662
PPU73/40	4147301	73	40	93	200	4,0	20	800	0,662
PPU75/40	4147501	75	40	92	200	4,0	20	800	0,662
PPU70/60	4107001	70	60	97	200	4,0	20	640	0,848
PPU80/60	4108001	80	60	92	200	4,0	20	640	0,848
PPU90/60	4109001	90	60	97	200	4,0	20	640	0,891
PPU96/60	4109601	96	60	94	200	4,0	20	640	0,891
PPU98/60	4109801	98	60	93	200	4,0	20	480	0,891
PPU100/60	4110001	100	60	92	200	4,0	20	640	0,891
PPU120/60	4112001	120	60	102	200	4,0	20	640	1,021
PPU140/60	4114001	140	60	92	200	4,0	20	640	1,021
PDL75/60-B	4220500	75	60	94	450	4,0	15	300	1,222
PDL100/60-B	4221000	100	60	92	450	4,0	15	300	1,259
PTB48	4070001	48	60	106	39	4,0	10	380	1,020
PH300	1773001	300	30	25	–	5,0	25	1575	0,349
PH350	1773501	350	30	25	–	5,0	25	1200	0,405
PH450	1774501	450	40	31	–	5,0	25	1300	0,712
PDKS48/40	4124801	48	40	88,5	334-408	4,0	10	390	1,070
PDKS98/60	4129801	98	60	88,5	334-408	4,0	10	200	1,310
PDKB48/40	4134801	48	40	88,5	169-234	4,0	10	400	1,060
PDKB98/60	4139801	98	60	88,5	169-234	4,0	10	400	1,300
PT30G	PT30G	80	24	–	300	–	1	324	1,900
PCR24/50G	PCR24/50G	80	24	123	531	–	1	480	1,700
PBR24/50G	PBR24/50G	80	24	123	495	–	1	480	2,100
PPH90	4900901	90	60	600	–	6,0	1	210	3,900
PPH100	4901001	100	60	600	–	6,0	1	210	3,960
PPH120	4901201	120	60	600	–	6,0	1	210	4,075
PPHB70	4910701	70	50	206	200	5,0;6,0	1	500	1,360
PPHB90	4910901	90	50	206	200	5,0;6,0	1	500	1,360
PPHB100	4911001	100	50	206	200	5,0;6,0	1	500	1,360
PPHB120	4911201	120	50	206	200	5,0;6,0	1	500	1,360
PPJET50/50/750	4930501	50	50	150	750	2,0	1	338	1,120
PPJET50/75/750G	4930701	50	75	150	750	2,0	1	300	1,740
PPJET50/100/750	4931001	50	100	150	750	2,0	1	255	2,040
PPJET75/75/750	4932001	75	75	150	750	2,0	1	144	2,010
PPJET100/100/750	4933001	100	100	150	750	2,0	1	225	2,640
PPJET70/70/750	4937501	70	70	150	750	2,0	1	140	1,880
PPJET90/90/900G	4939001	90	90	150	900	2,0	1	96	2,740
PPJET90/90/750G	4939101	90	90	150	750	2,0	1	256	2,390
PPJRE38/380	4903801	∅ 38	–	150	377	2,0	15	300	1,000
CP	CP	30	38	35	–	2,0	150	9000	0,049

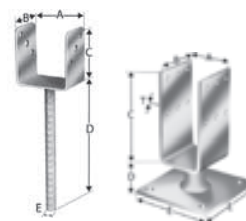

PPU/PDL

PTB

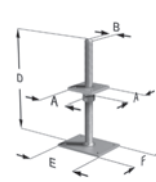

PT30G

PH

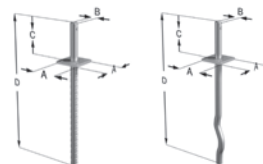

PCR24/50G

PBR24/50



PPH

PPHB



PDKS

PDKB

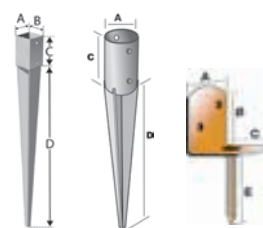

PPJET

PPJRE

CP

It. no. NEW č. p. NOVÉ nu. art. NOU	It. no. OLD č. p. STARÉ nu. art. VECHI	Dimensions/Rozměry/Dimensiuni [mm]			pcs. / package ks./bal. buc./pac.	pallet / pcs. pal./ks palet/buc.	kg / pcs. kg/ks. kg/buc.
		A	B	T			
FBAR12	2712800	12	10	0,8	20	960	0,527
FBAR12B	2712890	12	10	0,8	20	960	0,572
FBAR12W	2712891	12	10	0,8	20	960	0,572
FBAR12R	2712892	12	10	0,8	20	960	0,572
FBAR17	2717800	17	10	0,8	20	760	0,783
FBAR26-B	2726100	26	10	1,2	10	290	1,646
FBPR16	2716800	16	10	0,8	20	760	0,803
FBPR16B	2716890	16	10	0,8	20	760	0,871
FBPR16W	2716891	16	10	0,8	20	760	0,871
FBPR16R	2716892	16	10	0,8	20	760	0,871

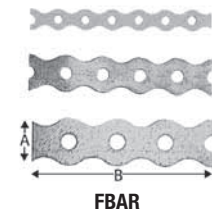

FBAR

FBPR

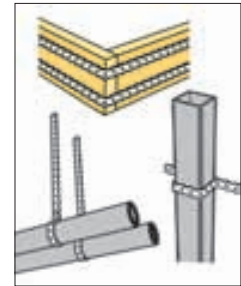

**Simpson Strong-Tie®**

**HOUSE AND GARDEN / DŮM A ZAHRADA / HOME SI GARDEN**

It. no. NEW č. p. NOVÉ nu. art. NOU	It. no. OLD č. p. STARÉ nu. art. VECHI	Dimensions/Rozměry/Dimensiuni [mm]				pcs. / package ks./bal. buc./pac.	pallet / pcs. pal./ks palet/buc.	kg / pcs. kg/ks. kg/buc.
		A	B	C	T			
SRC	SRC	Ø 61	55	82	44	20	–	0,180
SRR	SRR	Ø 61	55	80/100	44	20	1200	0,210
SRD	SRD	Ø 61	55	53	–	20	–	0,150
CF-R	CF-R	29	154	127	1,6	25	–	0,160
SBV	SBV	20	232	279	1,6	24	–	0,400
FLV40/100	FLV40/100	40	100	–	2,5	100	5800	0,080
FLV40/180	FLV40/180	40	180	–	3,0	100	4800	0,173
FLV55/135	FLV55/135	55	135	–	2,0	100	4800	0,119

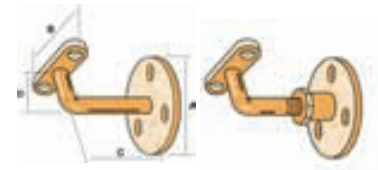

SRC

SRR



SRD

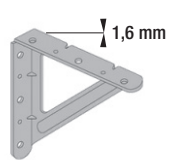

CFR

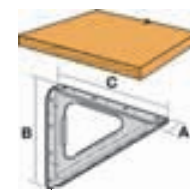

SBV

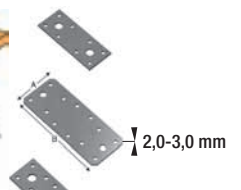

FLV

**Fasteners/Spojovací materiál/Elemente de fixare**

**SPAX®-SCREW / ŠROUB / SURUB**

It. no./č. pol./Nu. art.		Dimensions/Rozměry/Dimensiuni [mm]	pcs. / package ks./bal. buc./pac.	kg/ package kg/bal. kg/pac.
9556000	SPAX	6,0 x 60	200	1,600
9557000	SPAX	5,0 x 70	200	1,270
9558000	SPAX	5,0 x 80	200	1,450



ETA 04/0013

It. no. NEW č. p. NOVÉ nu. art. NOU	It. no. OLD č. p. STARÉ nu. art. VECHI	Dimensions/Rozměry/Dimensiuni [mm]		pallet / package pal./bal. palet/pac.	pcs. / package ks./bal. buc./pac.	pcs. / covering box ks./box buc./cart.	kg / package kg/bal. kg./pac.
		Ø	L				
CNA2,5x35	9925300	2,5	35	480	500	6000	0,867
CNA2,8x60	9928600	2,8	60	480	250	3000	0,825
CNA3,1x22	9931200	3,1	22	480	500	6000	0,842
CNA3,1x40	9931400		40	480	500	6000	1,348
CNA3,1x60	9931600		60	480	250	3000	0,966
CNA3,4x60	9934600	3,4	60	480	250	3000	1,183
CNA3,7x50	9937500	3,7	50	480	250	3000	1,180
CNA4,0x35	9943500	4,0	35	480	250	3000	1,033
CNA4,0x40	9944000		40	480	250	3000	1,133
CNA4,0x40G <sup>2)</sup>	9944060		40	480	250	3000	1,250
CNA4,0x40S <sup>3)</sup>	9944080		—	250	3000	1,133	
CNA4,0x50	9945000		50	480	250	3000	1,400
CNA4,0x50S <sup>3)</sup>	9945080		—	250	3000	1,400	
CNA4,0x60	9946000		60	480	250	3000	1,708
CNA4,0x60S <sup>3)</sup>	9946080		—	250	2000	1,708	
CNA4,0x75	9947500		75	480	250	3000	2,083
CNA4,0x100	9941000		100	320	250	2000	2,693
CNA6,0x60	9966020	6,0	60	80	100	800	1,348
CNA6,0x60S <sup>3)</sup>	9966080		—	100	800	1,525	
CNA6,0x80	9968020		80	192	100	-	1,840
CNA6,0x100	9961020		100	256	100	-	2,390

2) Galvanized/Pozinkované/Lot - galvanized -50µm

3) Stainless steel / Ušlechtilá ocel / Oțel inoxidabil 1.4401

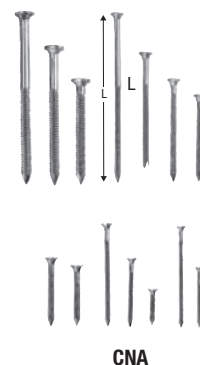

CNA



ETA 04/0013

It. no. NEW č. pol. NOVÉ nu. art. NOU	It. no. OLD č. pol. STARÉ nu. art. VECHI	Dimensions/Rozměry/Dimensiuni [mm]		pallet / package pal./bal. palet/pac.	pcs. / package ks./bal. buc./pac.	kg / package kg/bal. kg./pac.	
		Ø	L				
CSA4,0x30	9543000	4,0	30	480	250	0,755	
CSA5,0x25	9552500	5,0	25	480	250	0,628	
CSA5,0x25S <sup>3)</sup>	9552580		25	480	250	0,628	
CSA5,0x35	9553500		35	480	250	0,935	
CSA5,0x35S <sup>3)</sup>	9553580		35	480	250	0,935	
CSA5,0x40	9554000		40	480	250	0,975	
CSA5,0x40S <sup>3)</sup>	9554080		40	480	250	0,975	
	9555000 <sup>2)</sup>		50	50	672	250	1,150
CSA5,0x50DE <sup>1)</sup>							

1) Not suitable for ATF / Nevhodné pro ATF / Improprie pentru ATF

2) For ATF / Vhodné pro ATF / Adecvat pentru ATF

3) Stainless steel / Ušlechtilá ocel / Oțel inoxidabil 1.4401

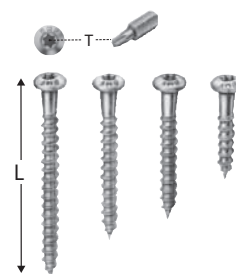

CSA

**SN-BATTEN NAILS / HŘEBÍKY DO KROKŮV / CUI ANCORA**

It. no. NEW č. pol. NOVÉ nu. art. NOU	It. no. OLD č. pol. STARÉ nu. art. VECHI	Dimensions/Rozměry/ Dimensiuni [mm]		pcs. / package ks./bal. buc./pac.	pallet / pcs. pal./ks palet/buc.	kg / package kg/bal. kg./pac.
		Ø	L			
SN6,0x80	9668020	6,0	80	125	–	2,450
SN6,0x110	9661120		110	125	–	3,350
SN6,0x150	9661520		150	125	–	4,530
SN6,0x180	9661820		180	125	–	5,550
SN6,0x210	9662120		210	125	–	6,450
SN6,0x230	9662320		230	125	–	7,130
SN6,0x260	9662620		260	125	–	8,020
SN6,0x280	9662820		280	125	–	8,610
SN6,0x300	9663020		300	125	–	9,210
SN6,0x330	9663320		330	125	–	10,450
SN6,0x350	–		350	125	–	10,570

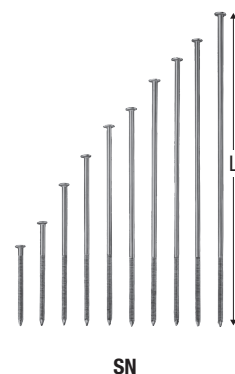
**CONCRETE SCREW / ŠROUB DO BETONU / SURUB DE BETON**

It. no. NEW č. pol. NOVÉ nu. art. NOU	It. no. OLD č. pol. STARÉ nu. art. VECHI	pcs. / package ks./bal. buc./pac.	pallet / package pal./bal. palet/pac.	kg / package kg/bal. kg./pac.

**STD STEEL DOWELS / KOLÍKY / TIJA DE FIXARE**

It. no. NEW č. pol. NOVÉ nu. art. NOU	It. no. OLD č. pol. STARÉ nu. art. VECHI	Dimensions/ Rozměry/Dimensiuni [mm]		pcs. / package ks./bal. buc./pac.	pallet / package pal./ks palet/ buc.	kg / pcs. kg/ks. kg/buc.
		Ø	L			
STD6x66-B	3304000	6	66	100	6600	0,014
STD8x45-B	3304500	8	45	100	6600	0,017
STD8x60-B	3306000	8	60	100	6600	0,024
STD8x65-B	3306500	8	65	100	6600	0,026
STD8x70-B	3307000	8	70	100	6600	0,027
STD8x80-B	3308000	8	80	100	6600	0,034
STD8x90-B	3309000	8	90	100	6600	0,036
STD8x100-B	3310000	8	100	100	6600	0,042
STD8x115-B	3311500	8	115	100	6600	0,046
STD8x120-B	3312000	8	120	100	5400	0,050
STD8x140-B	3314000	8	140	100	6600	0,056
STD8x160-B	3314200	8	160	100	5400	0,059
STD10x90-B	3315000	10	90	100	5400	0,056
STD10x100-B	3315100	10	100	100	5400	0,060
STD10x120-B	3315200	10	120	100	5400	0,073
STD10x140-B	3315300	10	140	100	5400	0,086
STD12x60-B	3319500	12	60	100	6600	0,054
STD12x65-B	3320000	12	65	100	5400	0,056
STD12x80-B	3320200	12	80	100	5400	0,074
STD12x90-B	3320500	12	90	100	5400	0,078
STD12x100-B	3320700	12	100	100	5400	0,091
STD12x110-B	3320800	12	110	100	5400	0,101
STD12x115-B	3321000	12	115	100	5400	0,100
STD12x120-B	3321200	12	120	100	5400	0,109
STD12x130-B	3321300	12	130	100	5400	0,111
STD12x140-B	3321500	12	140	100	5400	0,122
STD12x160-B	3322000	12	160	100	5400	0,145
STD12x180-B	3323000	12	180	100	5400	0,153
STD12x200-B	3323500	12	200	100	5400	0,160



STD

It. no. NEW č. pol. NOVÉ nu. art. NOU	It. no. OLD č. pol. STARÉ nu. art. VECHI	Dimensions/ Rozměry/Dimensiuni [mm]		pcs. / package ks./bal. buc./pac.	pallet / package pal./ks palet/buc.	kg / pcs. kg/ks. kg/buc.
		Ø	L			
STD16x120-B	3331000	16	120	50	2700	0,217
STD16x140-B	3331500	16	140	50	2700	0,232
STD16x150-B	3332000	16	150	50	2700	0,240
STD16x160-B	3332500	16	160	50	2700	0,299
STD16x180-B	3332800	16	180	50	2700	0,309
STD16x200-B	3333000	16	200	50	2700	0,319
STD16x250-B	3334000	16	250	50	2700	0,398
STD20x200-B	3343000	20	200	25	1350	0,497
STD20x250-B	3344000	20	250	25	1350	0,621
STD8x45G-B	3304560	8	45	100	6600	0,017
STD8x65G-B	3306560	8	65	100	6600	0,026
STD8x80G-B	3308060	8	80	100	6600	0,034
STD8x90G-B	3309060	8	90	100	6600	0,036
STD8x100G-B	3310060	8	100	100	6600	0,042
STD8x115G-B	3311560	8	115	100	6600	0,046
STD8x120G-B	3312060	8	120	100	5400	0,050
STD8x140G-B	3314060	8	140	100	5400	0,056
STD12x65G-B	3320060	12	65	100	5400	0,056
STD12x80G-B	3320260	12	80	100	5400	0,074
STD12x90G-B	3320560	12	90	100	5400	0,078
STD12x100G-B	3320760	12	100	100	5400	0,091
STD12x115G-B	3321060	12	115	100	5400	0,100
STD12x120G-B	3321260	12	120	100	5400	0,109
STD12x140G-B	3321560	12	140	100	5400	0,122

It. no. NEW č. pol. NOVÉ nu. art. NOU	It. no. OLD č. pol. STARÉ nu. art. VECHI	Dimensions/Rozměry/Dimensiuni [mm]				pcs. / package ks./bal. buc./pac.	pallet / pcs. pal./ks palet/buc.	kg / pcs. kg/ks. kg/buc.			
		d <sub>1</sub>	d <sub>c</sub>	h <sub>c</sub>	h <sub>1</sub>						
C2-50M10G-B	8000500	M10	50	6,6	-	300	43200	0,017			
C2-50M12G-B	8001000	M12				300	43200	0,019			
C2-50M16G-B	8002000	M16				300	43200	0,018			
C2-50M20G-B	8002500	M20				300	43200	0,016			
C2-62M12G-B	8003000	M12	62	8,7	-	150	21600	0,035			
C2-62M16G-B	8004000	M16				150	21600	0,034			
C2-62M20G-B	8005000	M20				150	21600	0,034			
C2-75M12G-B	8005500	M12	75	10,4	-	100	14000	0,048			
C2-75M16G-B	8006000	M16				100	14000	0,050			
C2-75M20G-B	8007000	M20				100	14000	0,050			
C2-75M22G-B	8007100	M22				100	14000	0,048			
C2-75M24G-B	8007200	M24	73x130	14,8	-	100	14000	0,048			
C2-95M16G-B	8008000	M16				95	12,7	-	50	5950	0,090
C2-95M20G-B	8008100	M20							50	5950	0,083
C2-95M22G-B	8008200	M22							50	5950	0,083
C2-95M24G-B	8008300	M24							50	5950	0,083
C2-117M16G-B	8009000	M16				117	16,0	-	40	2280	0,145
C2-117M20G-B	8010000	M20							40	2280	0,145
C2-117M22G-B	8010500	M22							40	2280	0,142
C2-117M24G-B	8011000	M24	40	2280	0,142						
C2-117M26G-B	8011500	M26	40	2280	0,142						
C4-70/130M16G-B	8013000	M16	73x130	14,8	-	50	3800				
C4-73/130M20G-B	8013500	M20				50	3800	0,113			
C4-73/130M24G-B	8014500	M24				50	3800	0,110			



C2

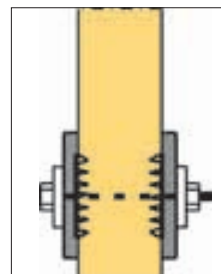

It. no. NEW č. pol. NOVÉ nu. art. NOU	It. no. OLD č. pol. STARÉ nu. art. VECHI	Dimensions/Rozměry/Dimensiuni [mm]				pcs. / package ks./bal. buc./pac.	pallet / pcs. pal./ks palet/buc.	kg / pcs. kg/ks. kg/buc.
		d <sub>1</sub>	d <sub>c</sub>	h <sub>c</sub>	h <sub>1</sub>			
C1-50-B	8020000	17	50	13,0	6,0	200	28800	0,015
C1-62-B	8020100	21	62	16,0	7,4	100	14400	0,030
C1-75-B	8020200	26	75	19,5	9,1	100	5700	0,050
C1-50G-B	8021000	17	50	13,0	6,0	200	28800	0,022
C1-62G-B	8022000	21	62	16,0	7,4	100	14400	0,039
C1-75G-B	8023000	26	75	19,5	9,1	100	5700	0,054
C1-95G-B	8024000	33	95	24,0	11,3	40	3800	0,094
C1-117G-B	8025000	48	117	30,0	14,3	25	1900	0,157
C5-100G-B	8026000	40	100	16,0	7,3	50	2850	0,114
C5-130G-B	8027000	52	130	20,0	9,3	25	1425	0,205
C3-73/130G-B	8028000	26	70x130	28,0	13,3	50	2850	0,113
C1-140G-B	8029000	60	140	31,0	14,7	25	2000	0,220
C1-165G-B	8029500	70	165	33,0	15,6	25	1000	0,360

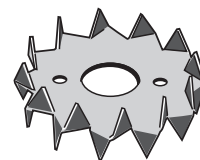

C1

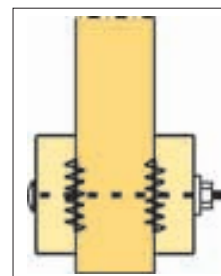



It. no. NEW č. pol. NOVÉ nu. art. NOU	It. no. OLD č. pol. STARÉ nu. art. VECHI	Dimensions/Rozměry/Dimensiuni [mm]				pcs. / package ks./bal. buc./pac.	pallet / pcs. pal./ks palet/buc.	kg / pcs. kg/ks. kg/buc.
		d <sub>1</sub>	d <sub>c</sub>	h <sub>c</sub>	d <sub>3</sub>			
A1-65-B	8046000	-	65	30	-	150	4800	0,060
A1-80-B	8046100		80	30		100	3200	0,080
A1-95-B	8046200		95	30		100	3200	0,095
A1-126-B	8046300		126	30		50	1600	0,126
A1-128-B	8046400		128	45		25	800	0,280
A1-160-B	8046500		160	45		25	800	0,340
A1-190-B	8046600		190	45		20	480	0,500
B1-65M12-B	8045000	M12	65	23	22,5	200	6400	0,050
B1-80M12-B	8045100	M12	80	23	35,5	100	3200	0,090
B1-95M12-B	8045200	M12	95	23	33,5	100	4000	0,130
B1-128M12-B	8045300	M12	128	32,5	45	50	1600	0,300
B1-160M16-B	8045400	M16	160	34,5	50	20	640	0,500
B1-190M16-B	8045500	M16	190	34,5	60	20	640	0,750



B1



A1

It. no. NEW č. pol. NOVÉ nu. art. NOU	It. no. OLD č. pol. STARÉ nu. art. VECHI	Dimensions/Rozměry/Dimensi- uni [mm]			pcs. / package ks./bal. buc./pac.	pallet / pcs. pal./ks palet/buc.	kg / pcs. kg/ks. kg/buc.
		d <sub>1</sub>	d <sub>c</sub>	h <sub>c</sub>			
C10-50-B	8041200	30,5	50	27	400	12800	0,050
C10-65-B	8041400	35,5	65	27	150	4800	0,093
C10-80-B	8041600	49,5	80	27	150	4800	0,113
C10-95-B	8041800	65,5	95	27	100	3200	0,140
C10-115-B	8042000	85,5	115	27	75	2400	0,187
C11-50M12-B	8040200	M12	50	15	400	12800	0,055
C11-65M16-B	8040400	M16	65	15	200	6400	0,090
C11-80M20-B	8040600	M20	80	15	200	6400	0,130
C11-95M24-B	8040800	M24	95	15	150	3600	0,173
C11-115M24-B	8041000	M24	115	15	75	2400	0,253

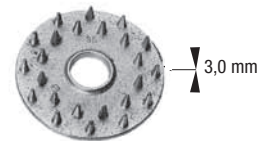

C11

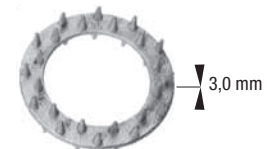

C10

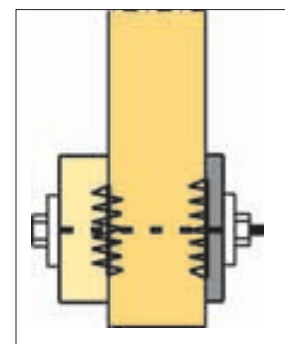

**U-WASHER/U-PODLOŽKA/SAIBA-U**

It. no. NEW č. pol. NOVÉ nu. art. NOU	It. no. OLD č. pol. STARÉ nu. art. VECHI	Dimensions/Rozměry/Dimensiuni [mm]				pcs. / package ks./bal. buc./pac.	pallet / pcs. pal./ks palet/buc.	kg / pcs. kg/ks. kg/buc.
		A	B	T	Ø			
US40/40/10G-B	0700100	40	40	10	13,5	50	4950	0,125
US40/50/10G-B	0700200	40	50	10	13,5x25	50	4950	0,157
US50/50/8G-B	0700300	50	50	8	18	50	4950	0,157
US60/60/6G-B	0700600	60	60	6	14	50	4950	0,125

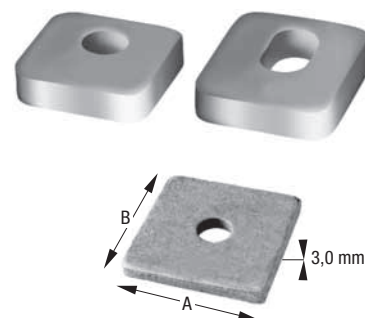
**KOLIBRODD®**

It. no. NEW č. pol. NOVÉ nu. art. NOU	It. no. OLD č. pol. STARÉ nu. art. VECHI	Dimensions/Rozměry/Dimensiuni [mm]	pallet / pcs. pal./ks palet/buc.	pcs. / package ks./bal. buc./pac.	kg / pcs. kg/ks. kg/buc.
KOLC1	8500000	Kolibrodd Skin 1 / Ø50	7200	300	0,027
KOLC2	8500100	Kolibrodd Skin 2 / Ø62	7200	300	0,042
KOLC3	8500200	Kolibrodd Sin 3 / Ø75	3600	150	0,060
KOLC4	8500300	Kolibrodd Skin 4 / Ø95	2400	100	0,095
KOLC8	8500500	Kolibrodd Skin 8 / 50x65	7200	300	0,035
KOLV1	8500600	Kolibrodd 1/ Ø50 Lose	14400	200	0,019
KOLV2	8500700	Kolibrodd 2/ Ø62 Lose	7200	100	0,034
KOLV8	8501100	Kolibrodd 8/50x65, Lose	7200	100	0,033



A series of horizontal dotted lines for writing notes, spanning the width of the page.

**SIMPSON****Strong-Tie**

®

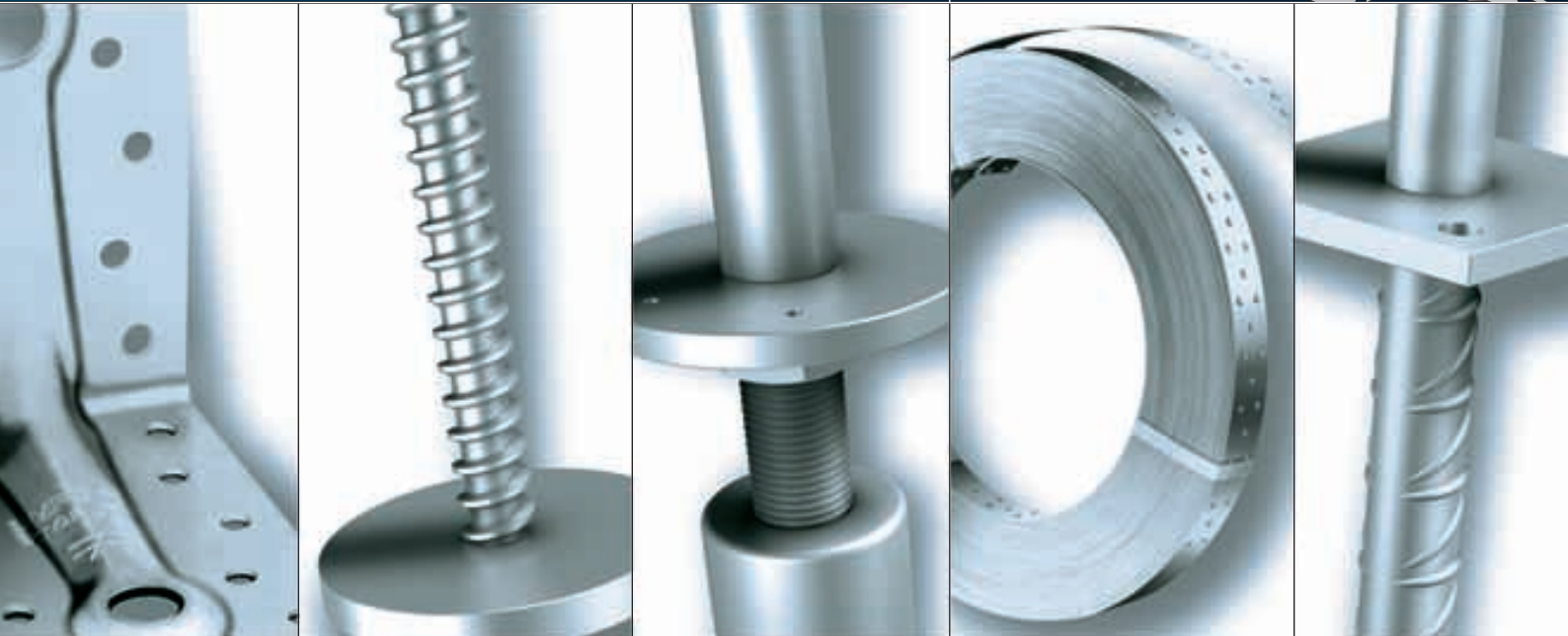
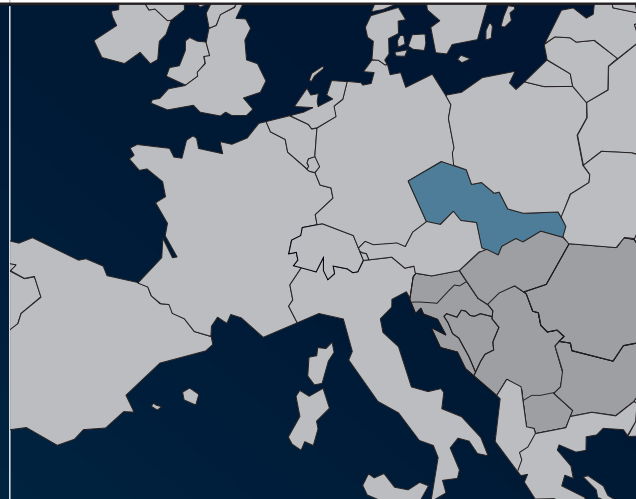
**EAST 2011/2012****SIMPSON STRONG-TIE® s.r.o.**

Kyjovská 3280

CZ-580 01 Havlíčkův Brod

Česká Republika

Tel.: +420 569433555

Fax: +420 569433561

info@strongtie.cz

www.strongtie.cz

www.strongtie.eu

**PRODUCTION AND WARHOUSE / VÝROBA  
A SKLAD / DE PRODUCTIE SI DEPOZITARE****DÄNEMARK**

Simpson Strong-Tie A/S  
Boulstrup  
DK-8300 Odder  
Tel.: +45 87 81 74 00  
Fax: +45 87 81 74 09  
info@simpsonstrongtie.dk  
www.simpsonstrongtie.dk

**FRANKREICH**

Simpson Strong-Tie  
Zac des Quatre Chemins  
F-85400 Sainte Gemme La Plaine  
Tel.: +33 2 51 28 44 00  
Fax: +33 2 51 28 44 01  
commercial@strongtie.com  
www.strongtie.eu

**ENGLAND**

Simpson Strong-Tie  
Winchester Road – Cardinal Point  
UK-Tamworth, Staffordshire B78 3HG  
Tel.: +44 1827 255 600  
Fax: +44 1827 255 616  
web-uk@strongtie.com  
www.strongtie.eu

**WAREHOUSE / SKLAD / DEPOZITARE****DEUTSCHLAND**

Simpson Strong-Tie® GmbH  
Riederhofstraße 27  
D-60314 Frankfurt  
Tel.: +49 69 67 737 89 0  
Fax: +49 69 67 737 89 69  
info@strongtie.de  
www.strongtie.eu  
www.strongtie.de

**POLEN**

Simpson Strong-Tie Sp. Z. o. o.  
PL-01-918 Warszawa  
Tel./Fax: +48 22 865 22 00  
info@simpsonstrongtie.pl  
www.simpsonstrongtie.pl

**SCHOTTLAND**

Simpson Strong-Tie  
Unit 6 Macintosh Road  
Kirkton Campus, Livingstone EH54 7BW  
Tel.: +44 1827 255600  
Fax: +44 1827 255616  
www.strongtie.co.uk

**SCHWEIZ**

(Verkauf und Beratung)  
Simpson Strong-Tie  
Bohnletweg 3  
CH-5024 Küttigen  
Tel.: +41 62 827 36 77  
Fax: +41 62 827 43 05  
info@simpsonstrongtie.ch

**HOME OFFICE / SÍDL0  
SPOLEČNOSTI /HOME OFFICE**

Simpson Strong-Tie  
5956 W. Las Positas Blvd  
Pleasanton, CA 94588  
U.S.A.  
Tel.: +1 925 560 9000  
Fax: +1 925 833 1496  
web@strongtie.com  
www.strongtie.com